

# 616 Mod-Fyre™ GSR2 Insert Owner's Manual



## **WARNING: FIRE OR EXPLOSION HAZARD**

Failure to follow safety warnings exactly could result in serious injury, death, or property damage.

- Do not store or use gasoline or other flammable vapors and liquids in the vicinity of this or any other appliance.
- **WHAT TO DO IF YOU SMELL GAS**
  - Do not try to light any appliance.
  - Do not touch any electrical switch; do not use any phone in your building.
  - Leave the building immediately
  - Immediately call your gas supplier from a neighbor's phone. Follow the gas supplier's instructions.
  - If you cannot reach your gas supplier, call the fire department.
- Installation and service must be performed by a qualified installer, service agency, or the gas supplier.

# ! DANGER



**HOT GLASS WILL CAUSE  
BURNS**

**DO NOT TOUCH GLASS  
UNTIL COOLED**

**NEVER ALLOW CHILDREN  
TO TOUCH GLASS**

**A barrier designed to reduce the risk of burns from the hot viewing glass is provided with this appliance and shall be installed for the protection of children and other at-risk individuals.**

Tested and Listed by



**Intertek**

Report# G100405040PRT-002

ANSI Z21.88:19

CSA 2.33:19

- **Direct Vent Fireplace Insert**
- **Masonry or Factory-Built (Metal) Wood-Burning Fireplace**
- **Residential or Mobile Home**

**This appliance may be installed in an aftermarket, permanently located, manufactured home (USA only) or mobile home, where not prohibited by local codes.**

**This appliance is only for use with the type of gas indicated on the rating plate. A conversion kit is supplied with the appliance.**

**INSTALLER: Leave this manual with the appliance.  
CONSUMER: Retain this manual for future reference.**

French language manuals at  
[fireplacex.com](http://fireplacex.com). or [lopistoves.com](http://lopistoves.com)  
Manuels de langue Française à  
[fireplacex.com](http://fireplacex.com). or [lopistoves.com](http://lopistoves.com)

## Introduction

We welcome you as a new owner of a 616 Mod-Fyre Insert. In purchasing this fireplace insert, you have joined the growing ranks of concerned individuals whose selection of an energy system reflects both a concern for the environment and aesthetics. It is one of the finest home heaters the world over. This manual will explain the installation, operation, and maintenance of this heater. Please familiarize yourself with the Owner's Manual before operating your heater and save the manual for future reference. Included are helpful hints and suggestions that will make the operation and maintenance of your new heater an easier and more enjoyable experience. We offer our continual support and guidance to help you achieve the maximum benefit and enjoyment from your heater.

## Important Information

No other 616 Mod-Fyre Insert has the same serial number as yours. The serial number is below and to the left of the gas control valve.

This serial number will be needed in case you require service of any type.

Model: 616 Mod-Fyre GSR2

Serial Number: \_\_\_\_\_

Purchase Date: \_\_\_\_\_

Purchased From: \_\_\_\_\_

Register your warranty online at:

[traviswarranty.com](http://traviswarranty.com)

**Save Your Bill of Sale.**

To receive full warranty coverage, you will need to show evidence of the date you purchased your heater.

We suggest that you attach your Bill of Sale to this page so that you will have all the information you need in one place should the need for service or information occur.

## Listing Details

This appliance was listed by Intertek. The listing label is attached to the appliance near the gas control valve. A copy is shown on page 47.

### Massachusetts Approval

This manual has been submitted to the Massachusetts Board of State Examiners of Plumbers and Gas Fitters.

### National Fireplace Institute



We suggest that our gas hearth products be installed and serviced by professionals who are certified in the U.S. by the National Fireplace Institute® (NFI) as NFI Gas Specialists.

<b>Introduction</b> .....	<b>2</b>	<b>Remote Set-Up</b> .....	<b>30</b>
<b>Important Information</b> .....	<b>2</b>	<b>Starting the Heater for the First Time</b> .....	<b>31</b>
<b>Listing Details</b> .....	<b>2</b>	<b>Location of Controls</b> .....	<b>31</b>
<b>Features</b> .....	<b>6</b>	<b>Direct Operation</b> .....	<b>31</b>
<b>Installation Options</b> .....	<b>6</b>	<b>Intermittent/Continuous Pilot</b> .....	<b>32</b>
<b>Heating Specifications</b> .....	<b>6</b>	<b>Remote Operation</b> .....	<b>33</b>
<b>Dimensions</b> .....	<b>6</b>	<b>Manual On-Off / Smart Thermostat / Standard Thermostat</b> .....	<b>35</b>
<b>Electrical Specifications (for blowers)</b> .....	<b>6</b>	<b>Mode Controls (Flame, Blower, Light, Comfort Control, Under Light)</b> .....	<b>36</b>
<b>Fuel</b> .....	<b>6</b>	<b>Mode Controls - continued</b> .....	<b>37</b>
<b>Installation Warnings</b> .....	<b>7</b>	<b>Display Fahrenheit or Celsius</b> .....	<b>37</b>
<b>Packing List</b> .....	<b>7</b>	<b>Low Battery Indicator</b> .....	<b>38</b>
<b>Additional Items Required</b> .....	<b>7</b>	<b>Battery Replacement</b> .....	<b>38</b>
<b>Order of Installation</b> .....	<b>7</b>	<b>Power Outages</b> .....	<b>38</b>
<b>Fireplace Requirements</b> .....	<b>8</b>	<b>Childproof Feature</b> .....	<b>39</b>
<b>Masonry Fireplace Hearth Requirements</b> .....	<b>8</b>	<b>Normal Operating Sounds</b> .....	<b>39</b>
<b>Factory-Built (Metal) Wood-Burning Fireplace Requirements</b> .....	<b>9</b>	<b>Normal Operating Odors</b> .....	<b>39</b>
<b>Hearth Requirements</b> .....	<b>9</b>	<b>Maintaining Your Heater's Appearance</b> .....	<b>40</b>
<b>Clearances</b> .....	<b>10</b>	<b>Accent Light Replacement</b> .....	<b>40</b>
<b>Televisions Placed Above the Insert</b> .....	<b>11</b>	<b>Under Light Bulb Replacement</b> .....	<b>41</b>
<b>Leveling Legs</b> .....	<b>13</b>	<b>Yearly Service Procedure</b> .....	<b>43</b>
<b>Electrical Requirements</b> .....	<b>14</b>	<b>Troubleshooting Table</b> .....	<b>44</b>
Re-Routing the Power Cord to the Front of the Insert .....	14	<b>Wiring Diagram</b> .....	<b>45</b>
Using the Insert Wiring Kit .....	14	<b>Replacement Parts</b> .....	<b>46</b>
<b>Gas Line Requirements</b> .....	<b>15</b>	<b>CONDITIONS &amp; EXCLUSIONS</b> .....	<b>48</b>
Gas Inlet Pressure .....	15	<b>IF WARRANTY SERVICE IS NEEDED:</b> .....	<b>48</b>
<b>Gas Line Installation</b> .....	<b>16</b>	<b>LP Conversion Instructions</b> .....	<b>49</b>
<b>Vent Requirements</b> .....	<b>17</b>	<b>Fireback Installation</b> .....	<b>53</b>
<b>Vent Installation</b> .....	<b>18</b>	<b>Media Options - Overview</b> .....	<b>56</b>
<b>Vent Location</b> .....	<b>19</b>	<b>Crushed Glass Installation (Optional)</b> .....	<b>57</b>
<b>Altitude Considerations</b> .....	<b>19</b>	<b>Rock Embers (Optional)</b> .....	<b>59</b>
<b>Vent Attachment – Tight Installations</b> .....	<b>20</b>	<b>Driftwood and Stones (Optional)</b> .....	<b>60</b>
<b>Exhaust Restrictor Settings</b> .....	<b>22</b>	<b>Birch Log Set (Optional)</b> .....	<b>61</b>
<b>Glass Frame Removal and Installation</b> .....	<b>25</b>	<b>Tumbled Stone (Optional)</b> .....	<b>62</b>
<b>Steps for Finalizing the Installation</b> .....	<b>26</b>	<b>Media Examples and Recipes</b> .....	<b>63</b>
<b>Before You Begin</b> .....	<b>29</b>		

- Failure to follow all of the requirements may result in property damage, bodily injury, or even death.

**Young children should be carefully supervised when they are in the same room as the appliance. Toddlers, young children, and others may be susceptible to accidental contact burns. A physical barrier is recommended if there are at-risk individuals in the house. To restrict access to a fireplace or stove, install an adjustable safety gate to keep toddlers, young children, and other at-risk individuals out of the room and away from hot surfaces.**

**Children and adults should be alerted to the hazards of high surface temperature and should stay away to avoid burns or clothing ignition. Do not touch the hot surfaces of the heater. Educate all children of the danger of a high-temperature heater.**

**Due to the high temperature, the heater should be located out of traffic and away from furniture and draperies.**

- This unit must be installed by a qualified installer to prevent the possibility of an explosion.
- This appliance must be installed in accordance with all local codes if any; if not, in U.S.A. follow ANSI Z223.1 and NFPA 54(88), in Canada follow CSA B149.1.
- A manufactured home (USA only) or mobile home OEM installation must conform with the Manufactured Home Construction and Safety Standard, Title 24 CFR, Part 3280, or, when such a standard is not applicable, the Standard for Manufactured Home Installations, ANSI/NCSCS A225.1, or Standard for Gas Equipped Recreational Vehicles and Mobile Housing, CSA Z240.4. This appliance may be installed in Manufactured Housing only after the home is site located.
- All exhaust gases must be vented outside the structure of the living-area. Combustion air is drawn from outside the living-area structure. The venting must not be connected to a chimney flue serving a separate solid-fuel burning appliance.
- Notify your insurance company before hooking up this fireplace.
- The instructions in this manual must be strictly adhered to. Do not use makeshift methods or compromise in the installation. Improper installation will void the warranty and safety listing.
- This heater is approved for use with natural gas (NG) or propane (LP). Burning the incorrect fuel will void the warranty and safety listing and may cause an extreme safety hazard. Direct questions about the type of fuel used to your dealer.
- Contact your local building officials to obtain a permit and information on any installation restrictions or inspection requirements in your area.
- If the flame becomes sooty, dark orange in color, or extremely tall, do not operate the heater. Call your dealer and arrange for proper servicing.
- It is imperative that control compartments, screens, or circulating air passageways of the heater be kept clean and free of obstructions. These areas provide the air necessary for safe operation.
- Do not operate the heater if it is not operating properly in any fashion or if you are uncertain. Call your dealer for a full explanation of your heater and what to expect.
- Do not store or use gasoline or other flammable liquids in the vicinity of this heater.
- Do not operate if any portion of the heater was submerged in water or if any corrosion occurs. Immediately call a qualified service technician to inspect the appliance and to replace any part of the control system and any gas control which has been under water.

### ***Safety Warnings (continued)***

---

- Because this heater can be controlled by a thermostat there is a possibility of the heater turning on and igniting any items placed on or near the appliance.
- Light the heater using the built-in igniter. Do not use matches or any other external device to light your heater.
- Never remove, replace, modify or substitute any part of the heater unless instructions are given in this manual. All other work must be done by a trained technician. Don't modify or replace orifices.
- The viewing glass should be opened only for conducting service.
- Allow the heater to cool before carrying out any maintenance or cleaning.
- Operate the heater according to the instructions included in this manual.
- If the main burners do not start correctly turn the gas off and call your dealer for service.
- This unit is not for use with solid fuel.
- Do not place anything inside the firebox (except the optional artwork).
- **Warning:** Do not operate the appliance with the glass front removed, cracked, or broken. Replacement of the glass should be done by a licensed or qualified service person.
- If the glass is broken, it must be fully cleaned up in a safe manner and the appliance must be inspected by a licensed or qualified service person.
- Do not throw this manual away. This manual has important operating and maintenance instructions that you will need at a later time. Always follow the instructions in this manual.
- Instruct everyone in the house how to shut the gas off to the appliance and at the gas main shutoff valve. The gas main shutoff valve is usually next to the gas meter or propane tank and requires a wrench to shut off.
- A barrier designed to reduce the risk of burns from the hot viewing glass is provided with this appliance and shall be installed for the protection of children and other at-risk individuals.
- If the barrier becomes damaged, the barrier shall be replaced with the manufacturer's barrier for this appliance.
- Clothing or other flammable material should not be placed on or near the appliance.
- Any safety screen, guard, or barrier removed for servicing an appliance must be replaced prior to operating the appliance.
- Installation and repair should be done by a qualified service person. The appliance should be inspected before use and at least annually by a professional service person. More frequent cleaning might be required due to excessive lint from carpeting, bedding material, et cetera. It is imperative that control compartments, burners, and circulating air passageways of the appliance be kept clean.
- **Travis Industries, Inc. grants no warranty, implied or stated, for the installation or maintenance of your heater, and assumes no responsibility for any consequential damage(s).**

### Features

- Works During Power Outages (battery backup system)
- Blowers and Remote Control Included
- Continuous or Intermittent (GreenSmart) Pilot
- Convenient Operating Controls
- Variable-Rate Heat Output
- Under lights and Accent Light

### Installation Options

- Residential or Mobile Home
- Fireplace Insert
- Masonry or Factory Built (Metal) Wood-Burning Fireplace

### Heating Specifications

Approximate Heating Capacity (in square feet)\*  
Maximum BTU Input Per Hour

#### Natural Gas

600 to 2,000  
39,000

#### Propane

600 to 2,000  
39,000

\* Heating capacity will vary with floor plan, insulation, and outside temperature.

### Dimensions

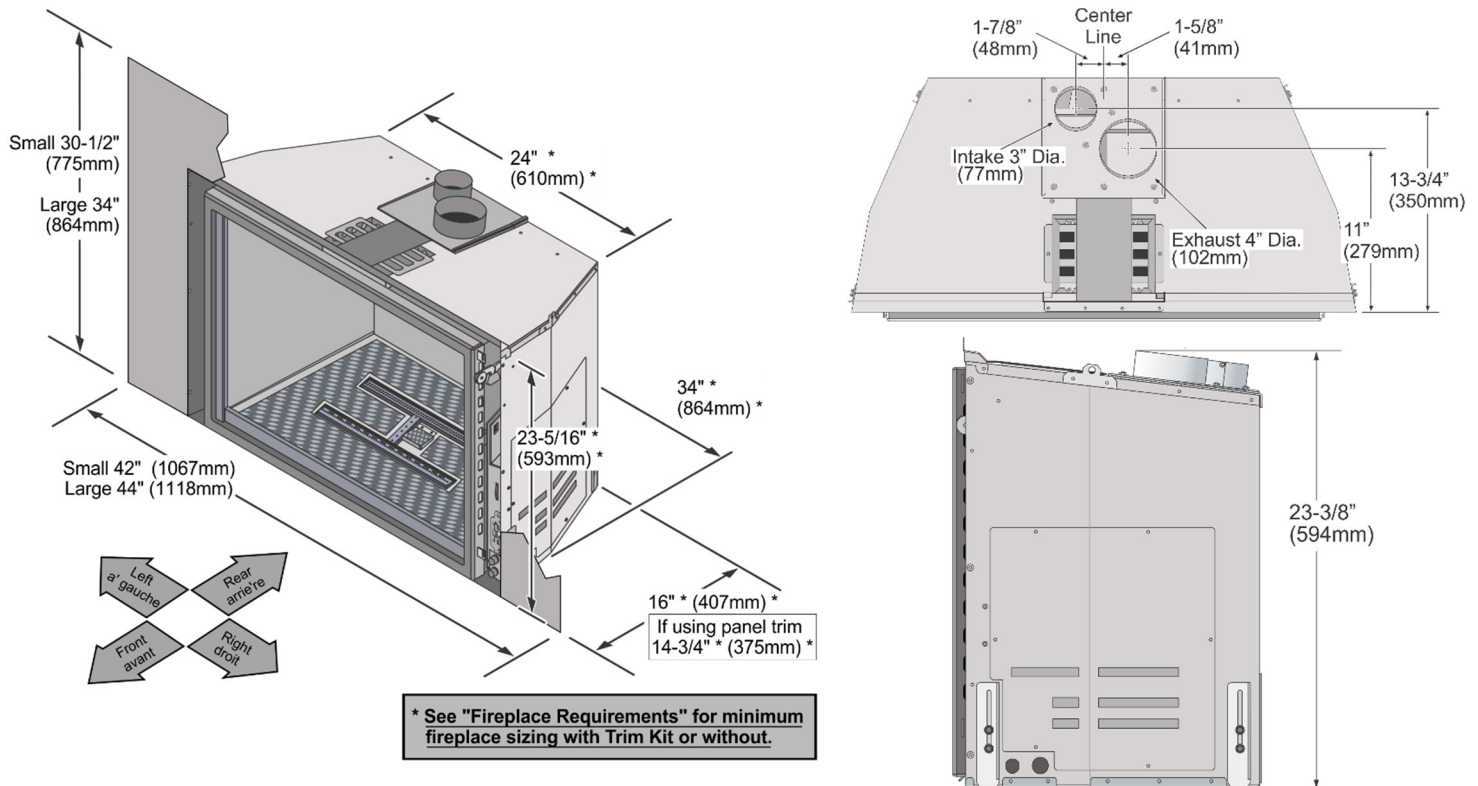

### Electrical Specifications (for blowers)

Electrical Rating

120 Volts, 1.8 Amps, 60 Hz (205 watts) (typical max amps: 5).

### Fuel

This heater is shipped in natural gas (NG) configuration but may be converted to propane (LP) using the LP Conversion Kit (included) and the LP stepper motor (sku# 250-01463 or 4 pk 94400999, sold separately). The sticker on top of the gas control valve will verify the correct fuel.

## Installation Warnings

---

- Failure to follow all of the requirements may result in property damage, bodily injury, or even death.
- This heater must be installed by a qualified installer who has gone through a training program for the installation of direct vent gas appliances.
- The installation must conform with local codes or, in the absence of local codes, the National Fuel Gas Code, ANSI Z223.1/NFPA 54, or the National Gas and Propane Installation Code, CSA B149.1.
- In Manufactured or Mobile Homes must conform with Manufactured Home Construction and Safety Standard, Title 24 CFR, Part 3280, or, when such a standard is not applicable, the Standard for Manufactured Home Installations, ANSI/NCSBCS A225.1. This appliance may be installed in Manufactured Housing only after the home is site located.
- The heater is designed to operate on natural gas, or propane (LP).
- All exhaust gases must be vented outside the structure of the living area. Combustion air is drawn from outside the living-area structure.
- Notify your insurance company before hooking up this heater.
- The requirements listed below are divided into sections. All requirements must be met simultaneously. The order of installation is not rigid – the qualified installer should follow the procedure best suited for the installation.

## Packing List

---

- Propane (LP) Conversion Kit
- Remote Control
- "Fireplace Altered" tag (attach to the fireplace)
- 46" Flex Line with Adapter and Shutoff Valve

## Additional Items Required

---

- 3" and 4" Diameter Gas Liner with Termination (Kit – sku# 96200340)
- Gas Line Equipment (shutoff valve, pipe, etc.)
- Surround Panel Kit
- Fireback Kit - Black Glass (sku# 96100931) or Black Painted (sku# 96100928) only.
- Media (Crushed Glass, Tumbled Stones, Rock Embers, Logs)
- Faceplate
- **If using LP (propane) a conversion kit is required (4-pack = 94400999, single = 250-01463).**

## Order of Installation

---

1. Run gas line to the fireplace
2. Remove the glass frame.
3. Run vent through fireplace chimney. On larger fireplaces, the vent connector may be left in place. For smaller fireplaces, remove the vent connector. See "Vent Connector Removal and Installation" for details.
4. Place the insert into position and attach the gas line and vent.
5. Remove the media tray.  
**NOTE:** If using propane (LP), remove the burner and convert the appliance at this time.
6. Install the firebacks.
7. Replace the burner if removed earlier for LP conversion.
8. Reinstall media tray (removed in step 5).
9. Install the media (Crushed Glass, Tumbled Stones, Rock Embers, Logs - see instructions included with the media).
10. Install the surround panel (see instructions included with the surround panel).
11. Replace the glass.
12. Install the face (see instructions included with the face).
13. Follow the instructions under "Finalizing the Installation".

## Fireplace Requirements

- Insert must be placed within a code-conforming masonry fireplace or tested and listed factory-built (metal) wood-burning fireplace. Repair any fireplace damage prior to installation.
- Because the insert uses a circulation blower, clean the fireplace, smoke shelf, and chimney prior to installation.
- This heater may be placed in a bedroom. Please be aware of the large amount of heat this appliance produces when determining a location.
- Do not place insulation or any other material on top of the insert. This may block the upper accent light ventilation, leading to premature bulb failure.
- The fireplace and fireplace chimney must be clean and in good working order and constructed of non-combustible materials.
- The chimney cleanouts must fit properly
- Trim panels or surrounds shall not seal ventilation openings in the fireplace

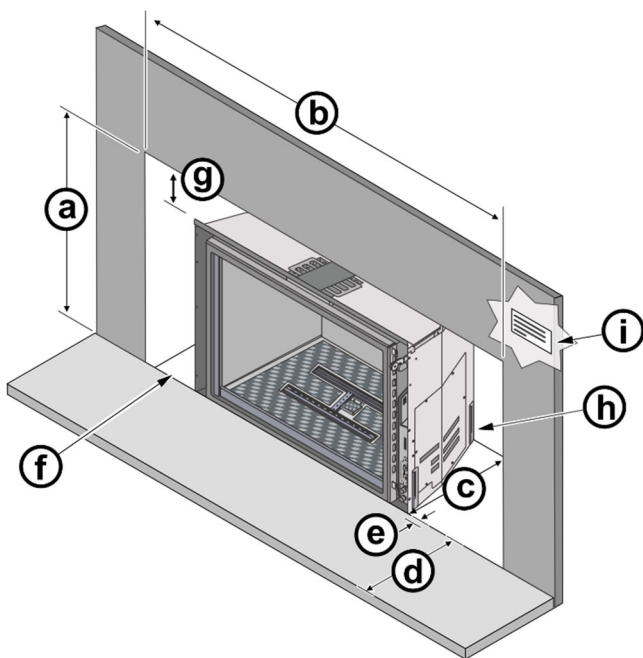

Fireplace Sizing	1-Piece Panel	1-Piece Panel w/ trim
(a) Minimum Height	24" (610mm)	23-1/2" (597mm)
(b) Minimum Width	35" (889mm)	34-5/8" (880mm)
(c) Minimum Depth	16-1/2" (420mm)	15-1/4" (387mm)
(d) Hearth Depth (see "Hearth Requirements" on the following page for full details)	0" (0mm)	0" (0mm)
(e) Hearth Extension	0" (0mm)	1-1/4" (32mm)

- (f) The gas and electrical line should be installed prior to installing the heater.
- (g) For tight fits (under 28") see the section "Removing the Vent Connector"
- (h) See "Leveling Legs" for details on leveling the heater.
- (i) Attach the "This fireplace has been altered..." plate to the fireplace (use two screws or other suitable method). You may wish to place it in a location where it will be covered by the surround panels.

### Fireplace Clearances to Gas Insert

Side of Insert to Inside of Fireplace	1/2" (13mm)
Back of Insert to Inside of Fireplace	1/2" (13mm)
Top of Insert to Inside of Fireplace	5/8" (18mm)

### Masonry Fireplace Hearth Requirements

A panel trim kit is available for this appliance. When using the kit, the appliance will sit forward of the fireplace opening 1-1/4" (32mm).

**WARNING:** A non-combustible hearth is not required in front of the appliance. However, if the heater is installed next to the floor, we recommend a hearth to protect the flooring surface from discoloration or other negative impacts from the heater.





## Factory-Built (Metal) Wood-Burning Fireplace Requirements

The damper ("A") and grate (with log set) ("B") must be removed (see the illustration below)

The smoke shelf ("C"), internal baffles ("D"), screen ("E"), masonry lining or refractory ("G" & "I"), and metal or glass doors ("F") may be removed (if applicable)

The fireplace must be permanently marked to indicate that it has been altered and is no longer suitable for burning solid fuel (wood) unless the removed parts are re-installed. Cutting of any sheet metal parts is prohibited.

WARNING: This fireplace has been converted for use with a fireplace insert and cannot be used for burning wood or solid fuels unless all original parts have been replaced and the fireplace re-approved by the authority having jurisdiction. 0530

The metal floor ("J") of the firebox may be removed in certain cases\*.

The insulation ("H"), and any structured rigid frame members must not be removed or altered (side and top of door frame, side, and top of the face of the fireplace, metal sides, etc.).

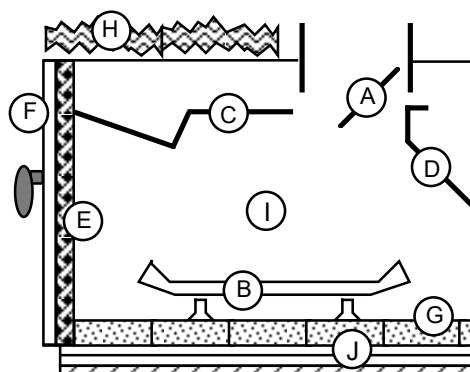

**\*CAUTION –** Removal of the firebox floor of a factory-built solid fuel fireplace in order to accommodate the installation of a gas-fired fireplace insert is not covered under (ANSI Z21.88 – CSA 2.22 or ANSI Z21.50 – CSA 2.33) standard(s) used to certify the gas-fired fireplace insert or UL 127 and ULC S627 standards used to certify solid fuel factory-built fireplaces. The Intertek safety certification will not apply to this installation method. This installation method must be deemed acceptable by the Authority Having Jurisdiction (AHJ) prior to the gas-fired fireplace insert being installed. The sheet metal base (or metal wrap) of the fireplace must be left in place and a minimum 1/2" cement board sheet placed under the entire length and width of the appliance.

If the factory-built fireplace has no gas access hole(s) provided, an access hole of 1-1/2 inches (37.5 mm) or less may be drilled through the lower sides or bottom of the firebox in a proper workman like manner. This access hole must be plugged with non-combustible insulation after the gas supply line has been installed.

## Hearth Requirements

- 1/2" of non-combustible material is required underneath the insert

**WARNING:** A non-combustible hearth is not required in front of the appliance. However, if the heater is installed next to the floor, we recommend a hearth to protect the flooring surface from discoloration or other negative impacts from the heater.



# 10

# Installation (for qualified installers only)

## Clearances

Due to the high temperature of the heater, it should be located out of traffic and away from furniture and draperies.

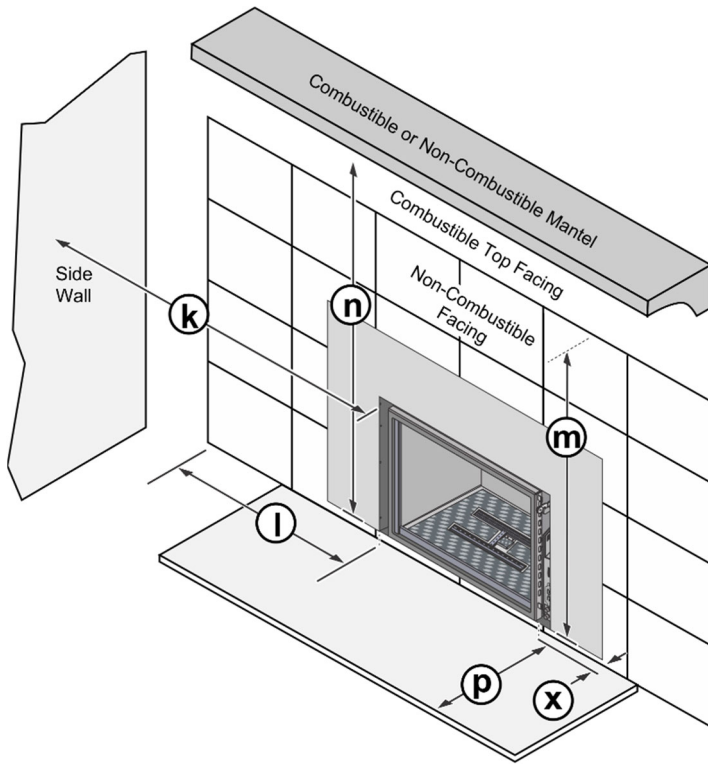

	Minimum Clearances
<b>k Sidewall to Insert</b>	6" (153mm)
<b>l Side Facing (non-combustible)</b>	5" (127mm)
<b>m Top Facing* (non-combustible)</b>	35-1/2" (902mm)
<b>n 12" Mantel* (combustible or non-combustible)</b>	36-1/2" (928mm)
<b>n 4" Mantel* (combustible or non-combustible)</b>	33" (839mm)
<b>p Hearth Extension to the Front</b>	0" (0mm)
<b>x Extension onto Hearth</b>	
1 Piece Panel	0" (0mm)
1 Piece Panel w/Trim Kit	1-1/4" (32mm)

\* Measured from the base of the insert.

**NOTE:** the non-combustible top facing must extend 35-1/2" (902mm) above the base of the insert or to the bottom of the mantel (whichever is less).

## Mantel Clearances

The maximum mantel depth is 12" (305mm).

**NOTE:** The combustible area above the non-combustible facing must not protrude more than 3/4" (20mm) from the facing. If it does, it is considered a mantel and must meet the mantel requirements listed in this manual.

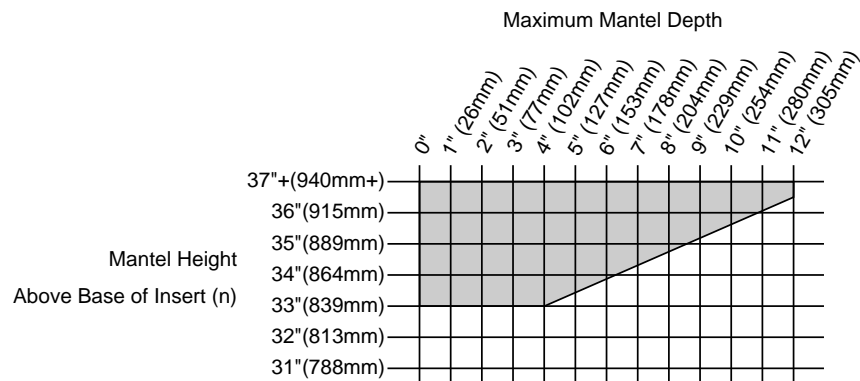

## Vinyl Flooring Hearth Recommendations

Vinyl flooring such as Luxury Vinyl Plank (LVP), Luxury Vinyl Tile (LVT), and other vinyl flooring can be sensitive to radiant heat and changes in temperature. If using vinyl flooring, we recommend installing the insert following the guidelines below. If these recommendations are not followed, the heat from the fireplace may cause discoloration, warping or other negative impacts.

**NOTE:** If using one of the hearth options, make sure to maintain the gap recommended by the manufacturer between the flooring and the hearth. Seal the gap with a flexible caulk to allow for expansion and contraction of the flooring.

(a)	(b)	(c)
Install the insert at floor level with a 27" (686mm) deep flush hearth (either combustible or noncombustible). The minimum width of the hearth is equal to the width of the fireplace opening.	The insert is elevated 12" (305mm) above the vinyl floor. No hearth is required. The vinyl flooring can be installed up to the wall or front of hearth if one is present.	Determine the height that the Insert will sit above the finished floor and use the chart below to determine the minimum recommended hearth depth.

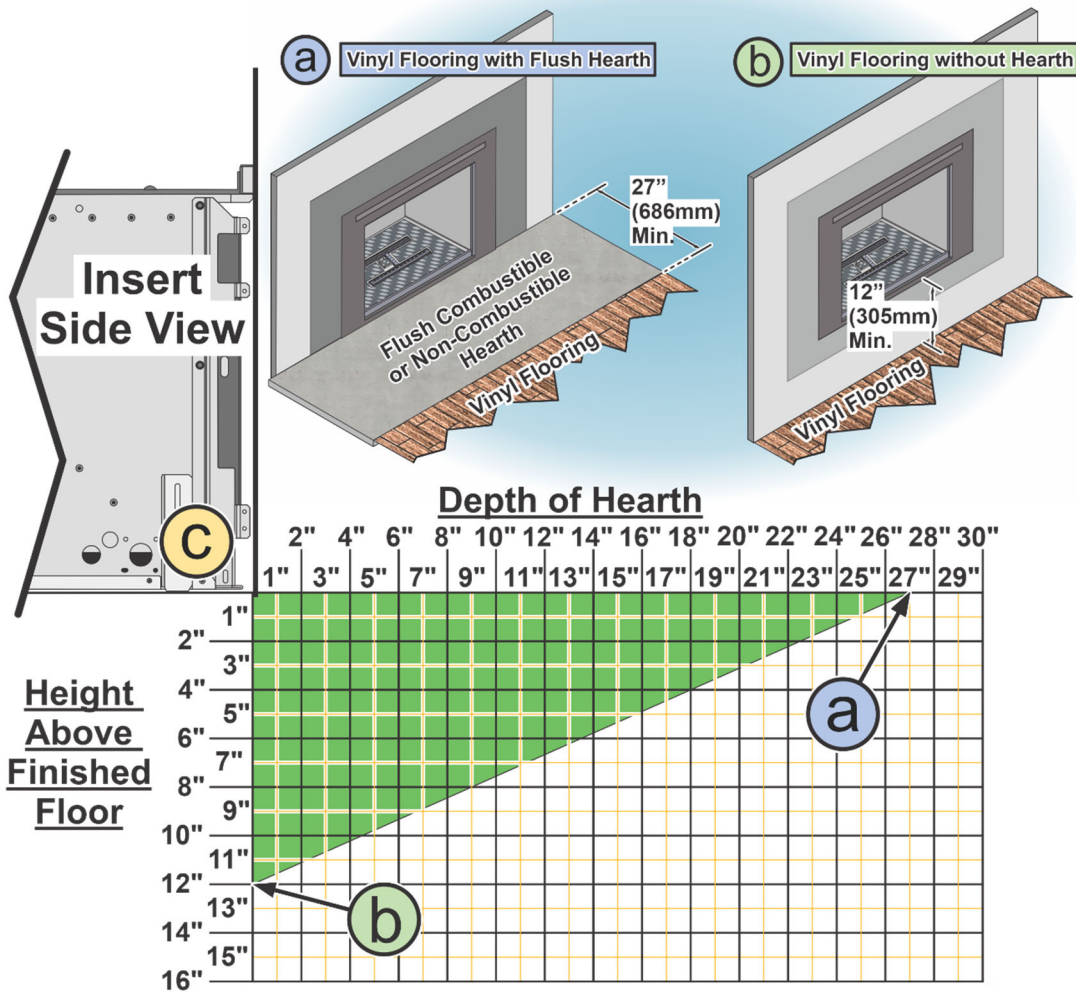

Inch	1"	2"	3"	4"	5"	6"	7"	8"	9"	10"	11"	12"	13"	14"	15"
mm	25	51	77	102	127	153	178	204	229	254	280	305	331	356	381
Inch	16"	17"	18"	19"	20"	21"	22"	23"	24"	25"	26"	27"	28"	29"	30"
mm	407	432	458	483	508	534	559	585	610	635	661	686	712	737	762

Televisions Placed Above the Insert

The following section gives guidelines to place a television above the insert.

**IMPORTANT NOTE REGARDING TELEVISIONS AND THIS INSERT**

Most television manufacturers instruct the homeowner not to place the television above a heat source like this insert. Doing so may decrease the longevity of the television and negate the warranty. If you do place a television above the insert, you should place a mantel between the insert and the television. Follow the guidelines below to reduce the amount of heat reaching the television. Travis Industries does not take responsibility for any negative impact on televisions placed near this insert.

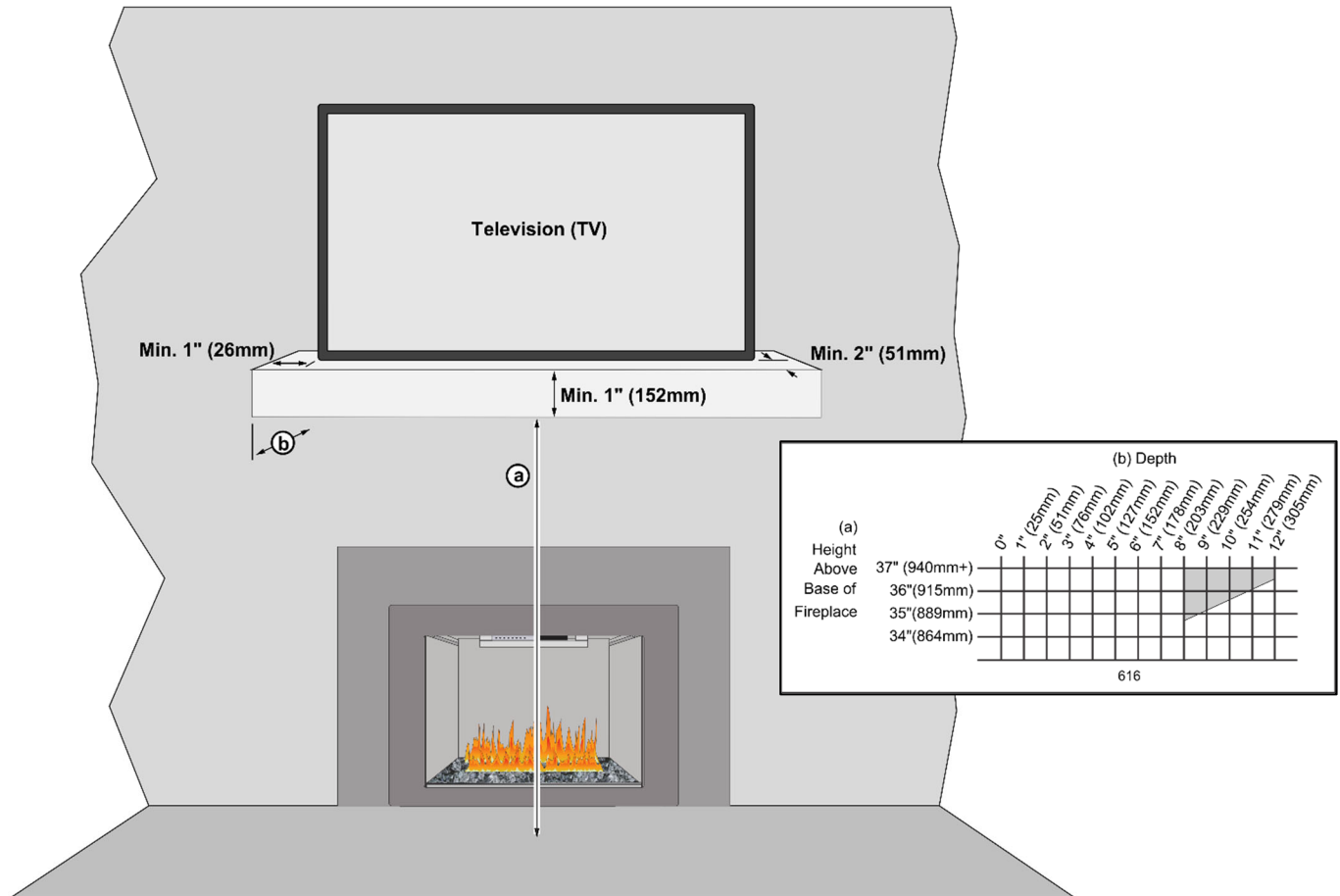

**Minimum Dimensions:**

(a) Minimum Mantel Height above Base of Insert*	34-3/4" (883mm) with 8" (204mm) mantel depth
(b) Minimum Mantel Depth*	8" (204mm)*

**\* Minimum mantel depth must be 8" (204mm) to allow heat to dissipate. If using a mantel larger than 8" (204mm), make sure to adjust the mantel height (a) to meet the mantel clearance (see mantel requirements on page 10 for details).**

- The mantel must extend 2" in front of the television and 1" to both sides.
- If you have a television that is greater than 6" deep (including the 1" gap behind), you will need to alter the mantel depth and height (see the example below).
- The television must have a 1" gap to the wall to allow for proper cooling.

**WIRING NOTE:** If running wiring into the enclosure, use thermal insulating wrap around the wiring. Secure the wiring to protect from contact with hot surfaces.

### Leveling Legs

This heater includes front and rear leveling legs to accommodate fireplaces with a step-down firebox. Loosen the (4) bolts and adjust the legs down until the insert is properly supported and level.



## Electrical Requirements

Travis Industries manufactures an "Insert Wiring Kit" for this insert (sku 97200315). This kit allows installers to wire 120-volt ac power into a fireplace directly to the insert, eliminating the need for an external power cord.

- Plug the power cord into a grounded 120-volt outlet (do not remove the grounding pin).
- The appliance, when installed, must be electrically grounded in accordance with local codes or, in the absence of local codes, with the *National Electrical Code, ANSI/NFPA 70*, or the *Canadian Electrical Code, CSA C22.1*.
- Do not route the power over the appliance or near any hot or moving components.

## Re-Routing the Power Cord to the Front of the Insert

The power cord is shipped attached to the side of the insert. It may be routed to the front where it exits behind the face but in front of the surround panel. See the directions below for details.

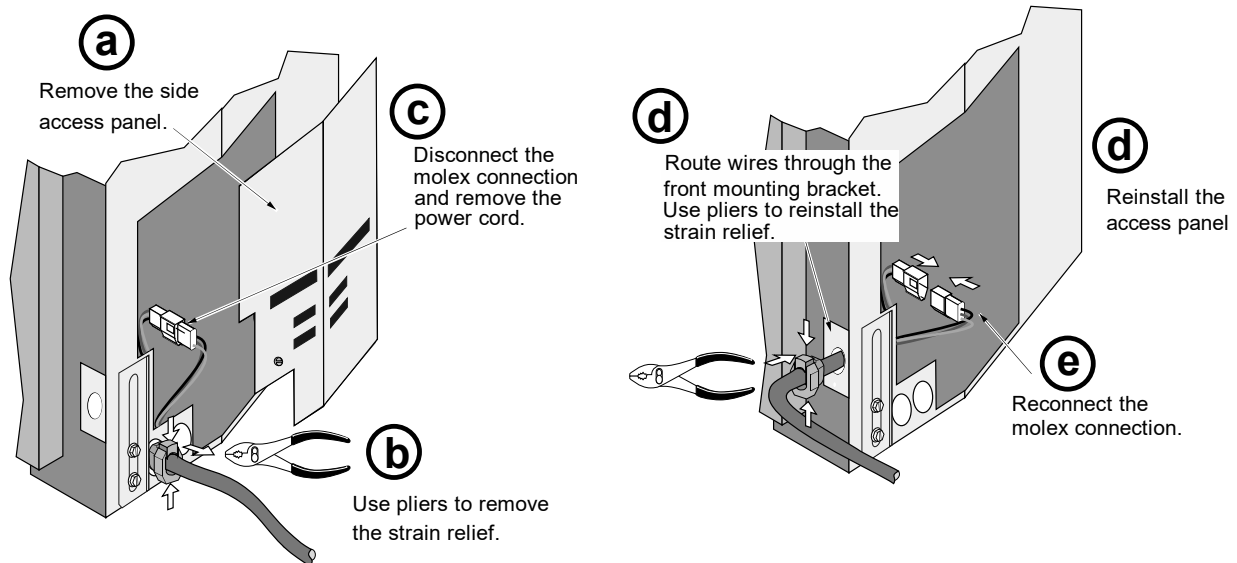

## Using the Insert Wiring Kit

See the instructions included with the Insert wiring kit for attaching the kit to the side of the insert.

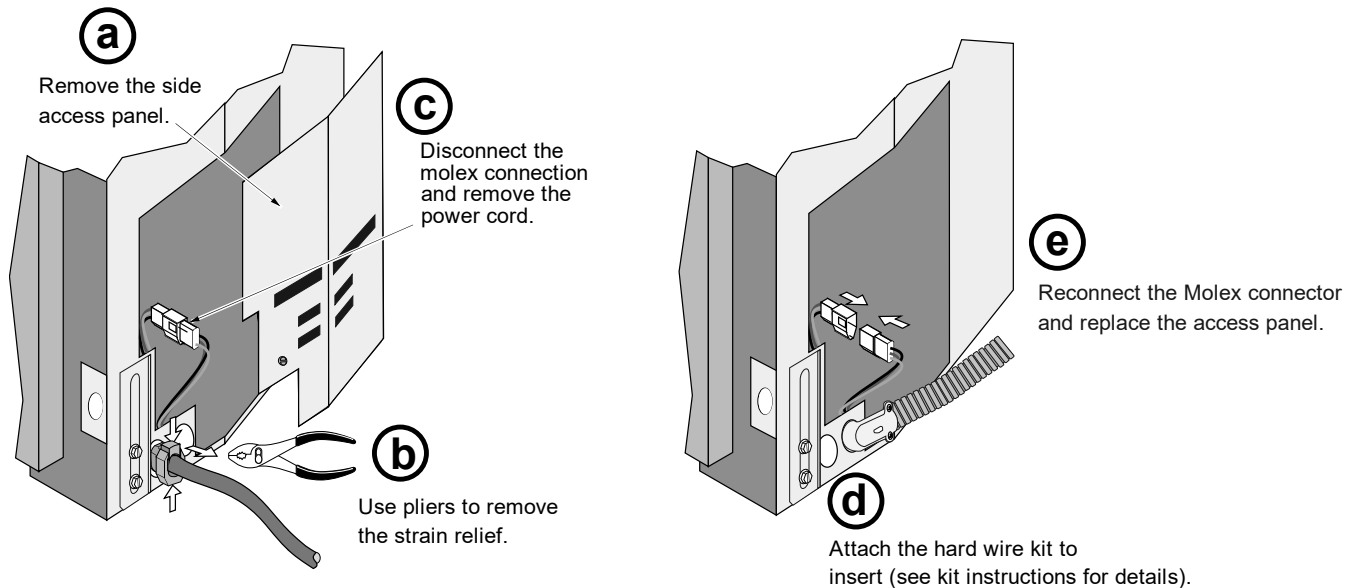

## Gas Line Requirements

### MASSACHUSETTS INSTALLATIONS - **WARNING:**

THIS PRODUCT MUST BE INSTALLED BY A LICENSED PLUMBER OR GAS FITTER WHEN INSTALLED WITHIN THE COMMONWEALTH OF MASSACHUSETTS.

#### OTHER MASSACHUSETTS CODE REQUIREMENTS:

- Flexible connector must not be longer than 36 inches.
- Shutoff valve must be a "T" handle gas cock.
- Only direct vent sealed combustion products are approved for bedrooms or bathrooms.
- Fireplace dampers must be removed or welded in the open position prior to the installation of a fireplace insert or gas log.
- A carbon monoxide (CO) detector is required in the same room as the appliance.

- The gas line must be installed in accordance with all local codes if any; if not, follow ANSI 223.1 and the requirements listed below.
- A manual shutoff valve is required within 3' of the heater. It should be placed upstream of the flex line (if used) and may be installed behind the access door inside the heater. ).
- The heater and gas control valve must be disconnected from the gas supply piping during any pressure testing of that system at test pressures in excess of 1/2 psig. For pressures under 1/2 psig, isolate the gas supply piping by closing the manual shutoff valve.
- Leak test all gas line joints and the gas control valve prior to and after starting the heater.
- This heater is designed either for natural gas or propane (but not for both). Check the sticker on the top of the gas control valve to make sure the correct fuel is used (see illustration on page 4).
- Installation must be performed by a qualified installer, service agency, or the gas supplier (In Massachusetts a licensed plumber/gas-fitter).

## Gas Inlet Pressure

Gas Pressure	Max. Input Pressure	Min. Input Pressure	Max. Manifold Pressure	Min. Manifold Pressure
<b>Natural Gas</b>	7" W.C. (1.74 kPA)	5.5" W.C. (1.37 kPA)	3.5" W.C. (0.87 kPA)	1.6" W.C. (0.40 kPA)
<b>Propane</b>	13" W.C. (3.23 kPA)	11" W.C. (2.74 kPA)	11" W.C. (2.74 kPA)	2.9" W.C. (0.72 kPA)

- If the pressure is not sufficient, make sure the piping used is large enough, the supply regulator is adequately adjusted, and the total gas load for the residence does not exceed the amount supplied.
- The supply regulator (the regulator that attaches directly to the residence inlet or the propane tank) should supply gas at the suggested input pressure listed above. Contact the local gas supplier if the regulator is at an improper pressure.

### Directions for Connecting a Gas Pressure Test Gauge

The gas control valve (shown to the right) has two test ports for testing input (line pressure) and output (manifold) pressure. Loosen the brass screw on either test port and place a 5/16" i.d. rubber or plastic tube over the tapered test port. Connect the tube to the test gauge.

**WARNING:** The brass screw must be tightened after testing to prevent gas leakage.

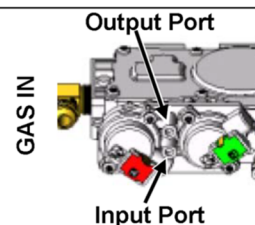

# 16

## Installation (for qualified installers only)

### Gas Line Installation

Route the included flex tube through the hole in the left side of the insert and out the front as shown below.

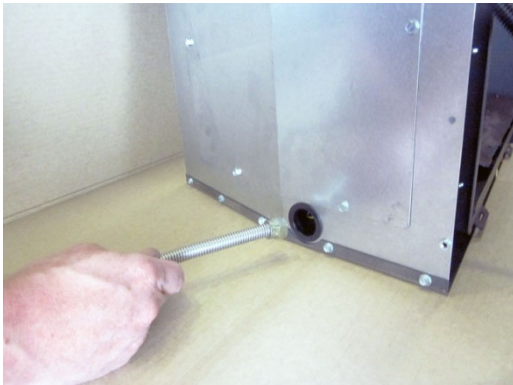

Bend the flex tube up.

Attach the included gas shutoff valve to the end of the flex tube and gas inlet as shown below. Position so the valve is on the right as shown.



Leak-test all gas line connections.



## Vent Requirements

Travis Industries manufactures a vent kit specifically for this insert (sku 96200340). It includes 30' (10M) of vent, hose clamps, and a high wind cap. The flashing on the cap is 18" (458mm) by 18" (458mm).



Travis Industries manufactures a vent kit specifically for this insert (sku 96200331). It includes 30' (10M) of vent, hose clamps, and a prairie cap. The flashing on the cap is 18" (458mm) by 18" (458mm).



- The gas appliance and vent system must be vented directly to the outside of the building, and never be attached to a chimney serving a separate solid fuel or gas-burning appliance. Each direct vent gas appliance must use its own separate vent system.
- Make sure the exhaust pipe on the heater connects to the exhaust portion of the cap. The illustrations below show how the flex liners should be attached.
- The exhaust vent must reline the entire length of the chimney and terminate above the chimney top
- Be careful not to crimp or rupture the liner when bending it into chimney offsets
- When installed, the vent must meet all of the vent manufacturer's requirements
- Use the following vent:  
 4" UL 441 or 1777 Gas Liner for Exhaust, 3" UL 441 or 1777 Gas Liner for Air Inlet  
 Duravent 6-5/8" to 3" & 4" Co-Linear Adapter and Flashing (Travis Part # 98900124).  
 Duravent High-Wind Vertical Termination (46DVA-VCH) **must be used**.  
 Duravent High-Wind Vertical Termination (46DVA-VCH) for high-wind applications or Prairie Cap

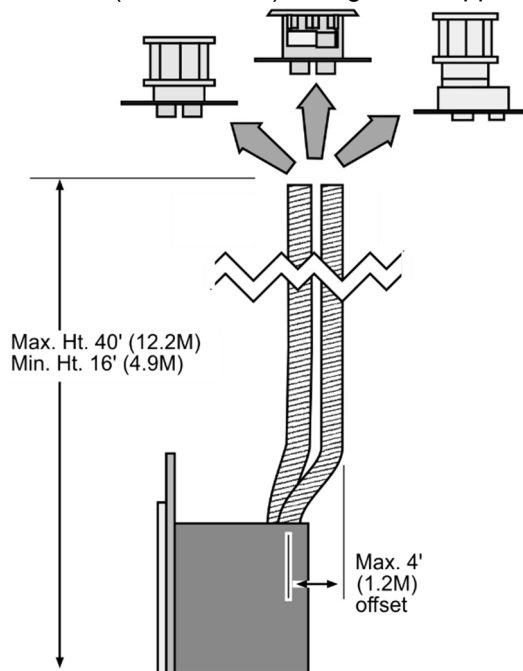

### Drafting Performance

This direct vent appliance requires natural draft to operate (similar to a wood stove or other heating appliance). Draft can be adjusted using the included restrictor. The restrictor settings detailed in the manual should be followed (variations may occur depending upon installation parameters).

Many factors may negatively influence the draft of the appliance. Travis Industries will not be responsible for improper draft due to factors such as trees, hills, buildings, obstructions, excessive wind, extreme hot or cold outdoor

# 18

# Installation (for qualified installers only)

temperatures, restrictive vent terminations, or influence from mechanical systems.

## Vent Installation

Secure the vent to the insert and termination kit using screws.

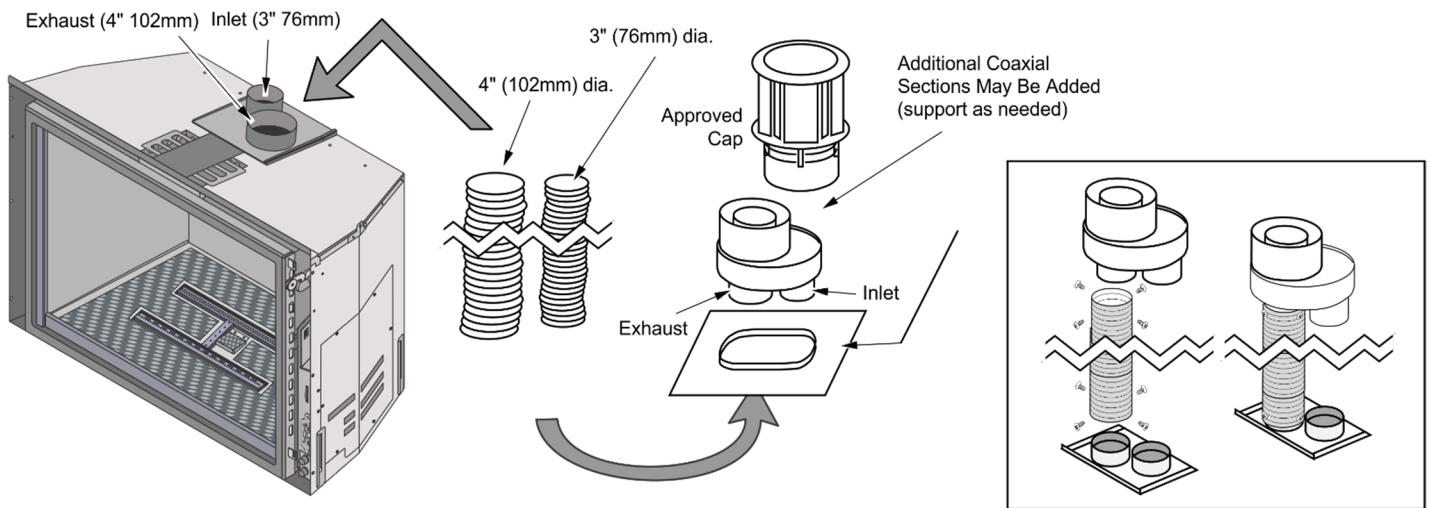

For optimum performance, keep the vent as straight as possible (no 90° bends).

## Vent Location

- An Exhaust Restrictor is built into the appliance to adjust the flow rate of exhaust gases. This ensures proper combustion for all vent configurations. Depending upon the vent configuration, you may be required to adjust the restrictor position.

## Vent Configurations

### Inlet & Exhaust Re-Line

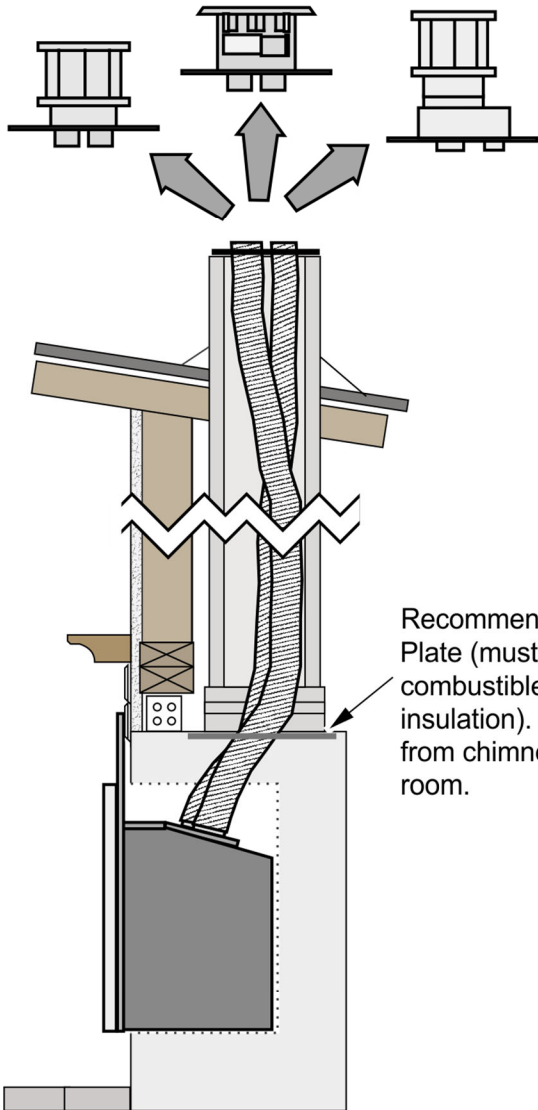

**Factory Built (Metal) Wood-Burning Fireplace**

### Exhaust Only Re-Line

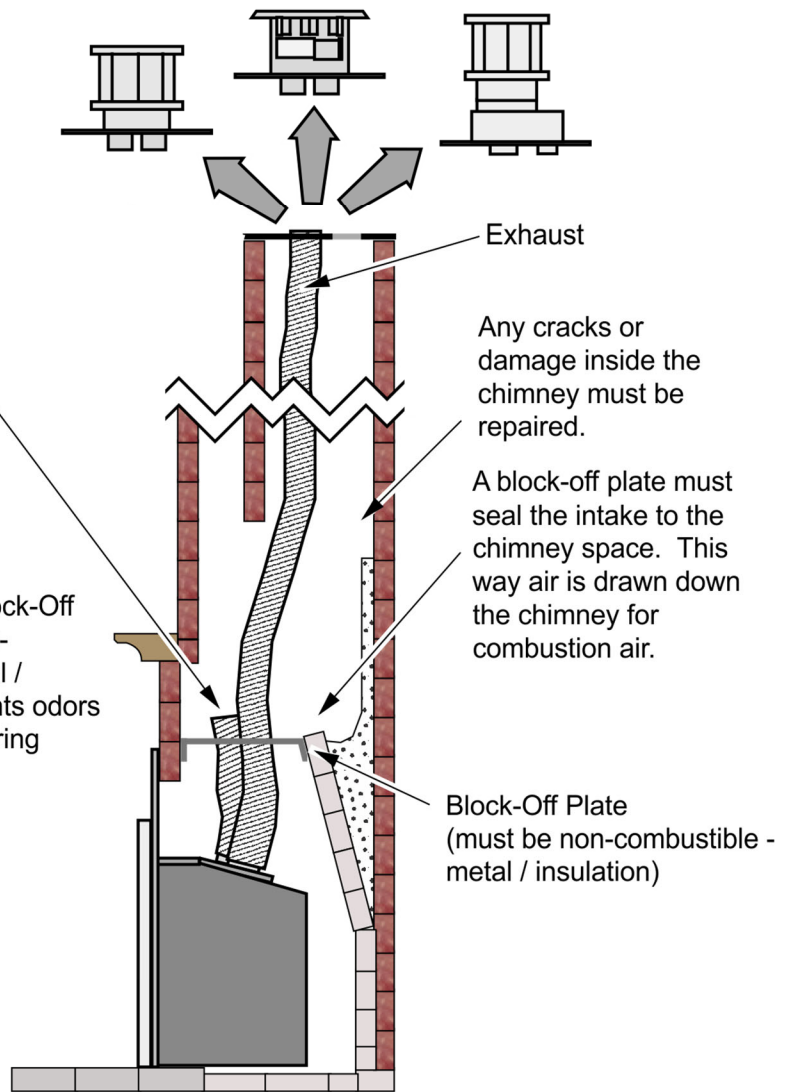

**Masonry Fireplace**

**NOTE:** You may use either re-line configuration with a masonry or zero-clearance fireplace.

## Altitude Considerations

- This heater has been tested at altitudes ranging from sea level to 6,000 feet (1,800 M). In this testing, we have found that the heater, with its standard orifice, burns correctly with just an air shutter adjustment.
- Failure to adjust the air shutter properly may lead to improper combustion which can create a safety hazard. Consult your dealer or installer if you suspect an improperly adjusted air shutter.

**Vent Attachment – Tight Installations**

The vent connector is shipped attached to the insert but must be removed to facilitate tight installations. See the directions below for installation.

1. Locate the screw in the top center of the front of the insert. Use a 1/4" nut driver to remove the screw and slide the connector toward the back of the insert to disengage the connector from the top of the insert.

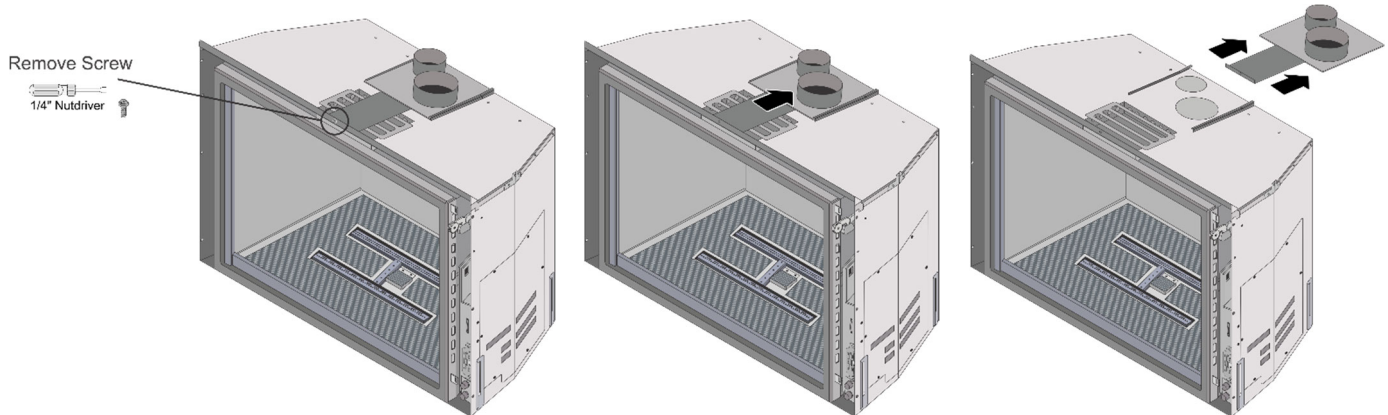

2. Stretch the liners to their full length. Attach the flex liners to the cap (secure with screws). Route the flex vent through the chimney from above.

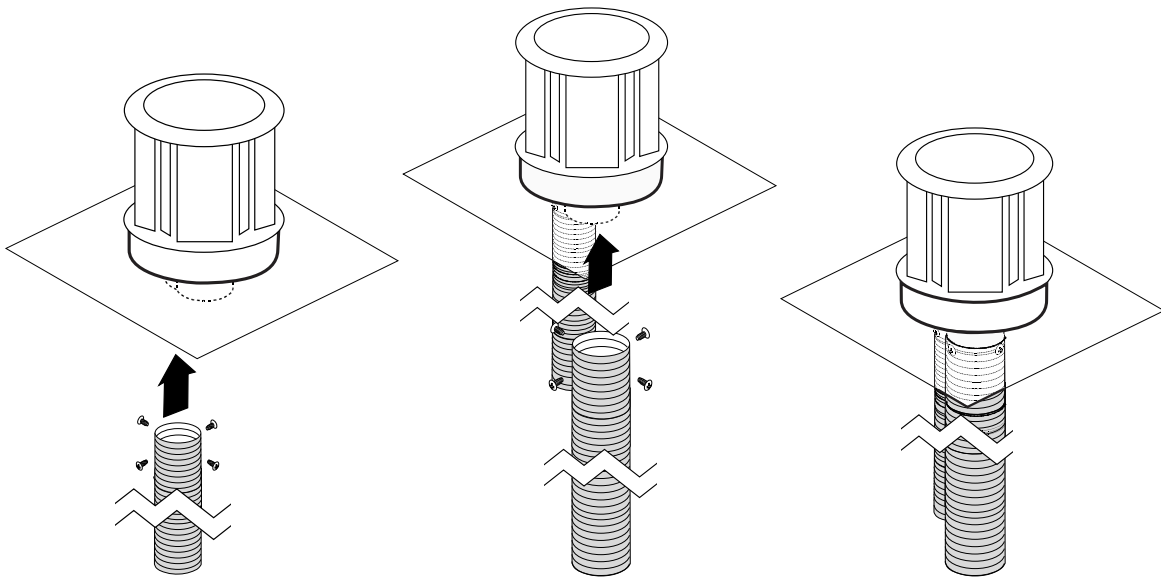

3. Pull the liners straight and cut to length (height of the insert). Attach the bottom of the flex liners to the connector, removed in step 1.

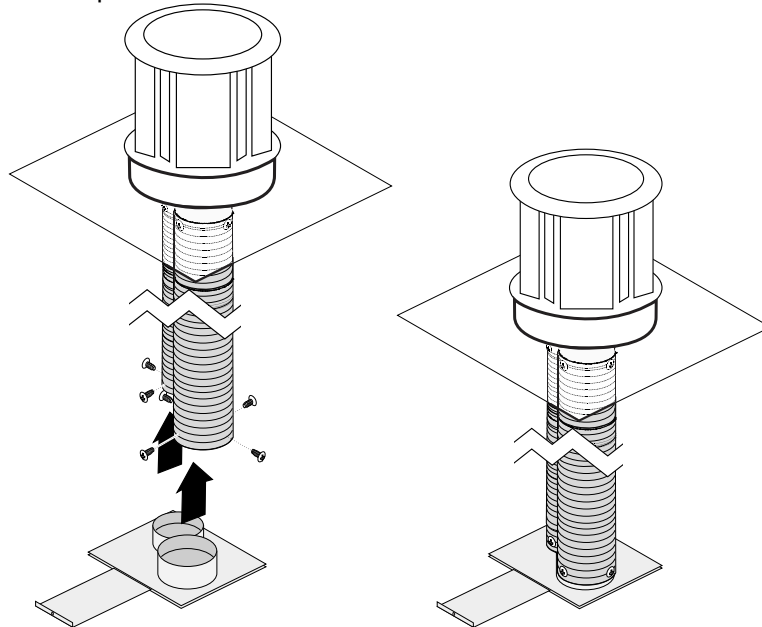

4. Slide the insert into place while guiding the vent connector into the guides on top of the insert. Secure the vent connector to the appliance using the screw removed in step 1.

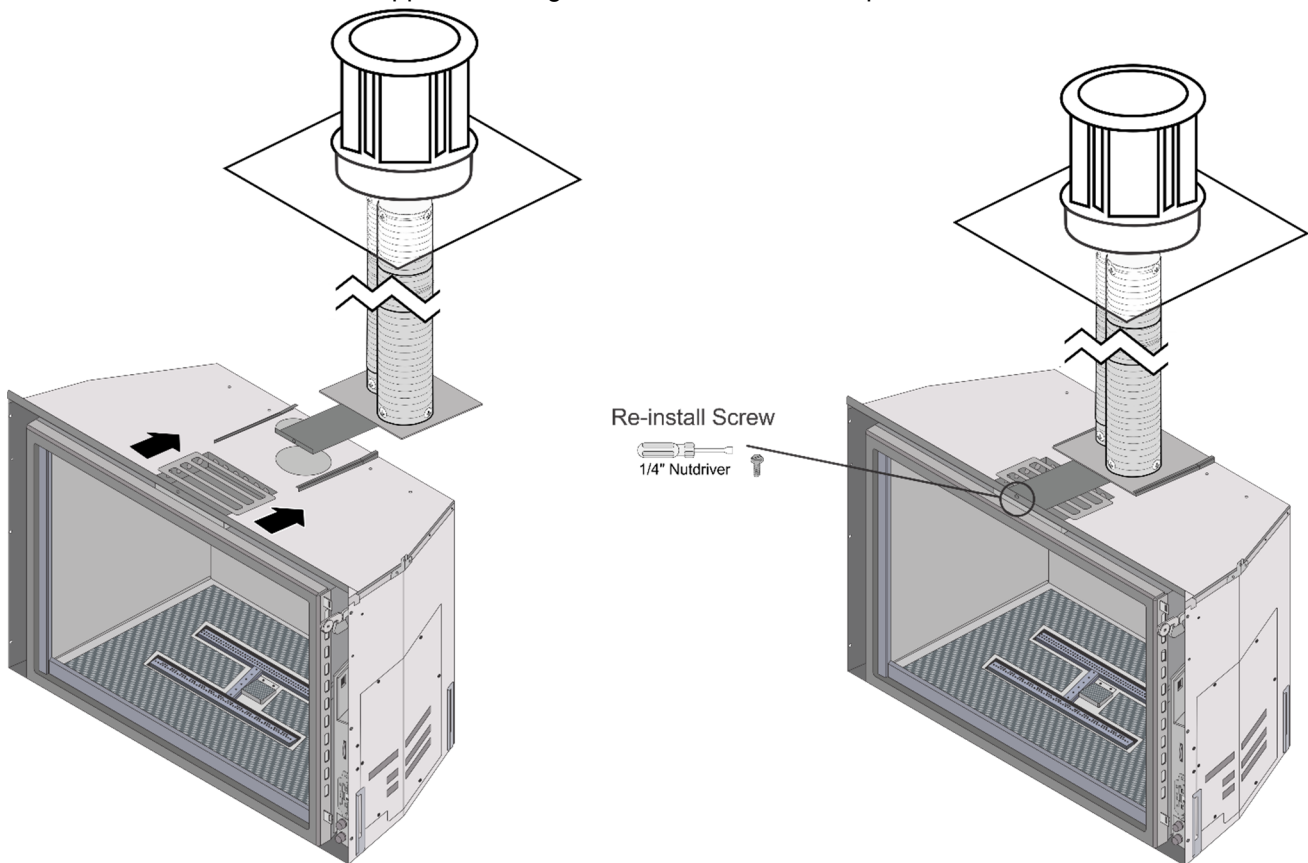

**Exhaust Restrictor Settings**

Use a 1/4" nut driver to loosen the screws that secure the baffle to the top of the firebox. Slide the baffle slightly forward until the screw heads are in line with the keyhole slots. Lower the baffle and remove from the firebox. (Re-install baffle after the restrictor has been adjusted).

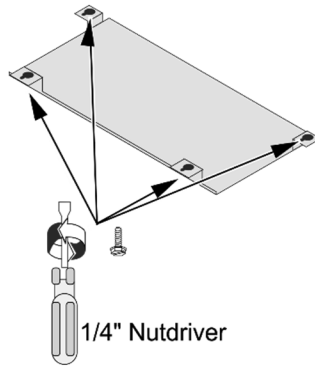

Slide the restrictor to the correct position (consult the vent chart to the right to determine the proper setting for your installation). The screw location indicates the restrictor position.

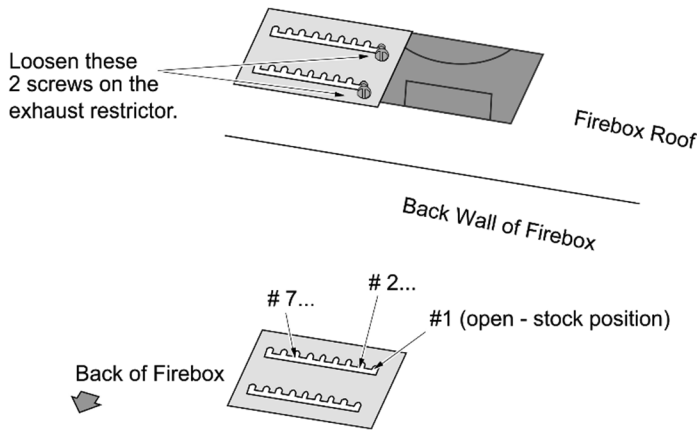

In this example, the restrictor is set in the #5 position. Tighten the screws to secure the restrictor.

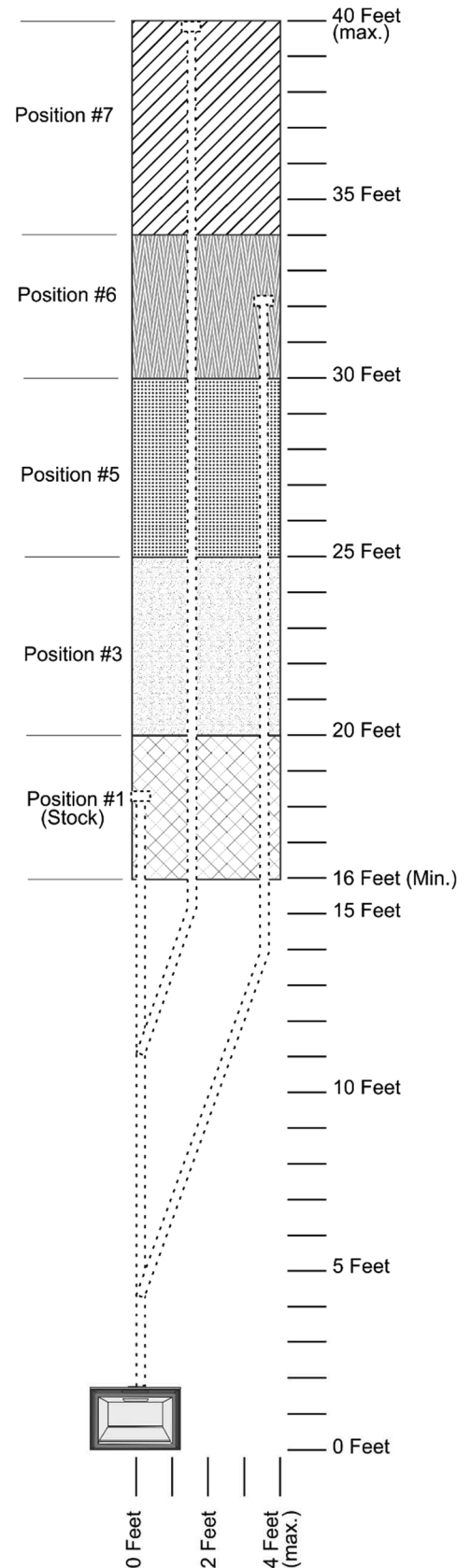
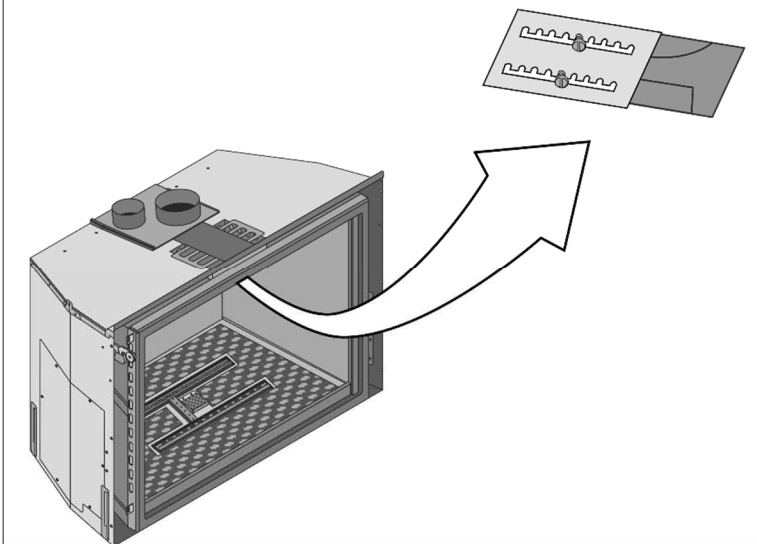

## Horizontal Termination

DuraVent manufactures a vent kit for horizontal that allows for terminating horizontally when installed in a masonry fireplace (not for use with ZC fireplaces). The DuraVent kit (46DVA-HCL33 and 46DVA HCL34) is approved for use with Travis Industries gas inserts.

These kits can be purchased from your Travis Industries dealer.

Application	DuraVent Part #
For inserts that use 3" exhaust and 3" intake	46DVA-HCL33
For inserts that use 4" exhaust and 3" intake	46DVA-HCL34

Refer to the kit manufacturer's instructions for details and requirements for installation. In addition to the manufacturer's requirements, the following requirements must be met:

- The termination center **MUST** be a minimum of 5' from the base of insert.
- The termination center **MUST NOT** be more than 8' from the base of the insert.
- The radius of any bends in the flexible venting **MUST NOT** be less than a 4" radius
- All portions of the venting **MUST** have at least a 1/4" rise per 12" of horizontal run

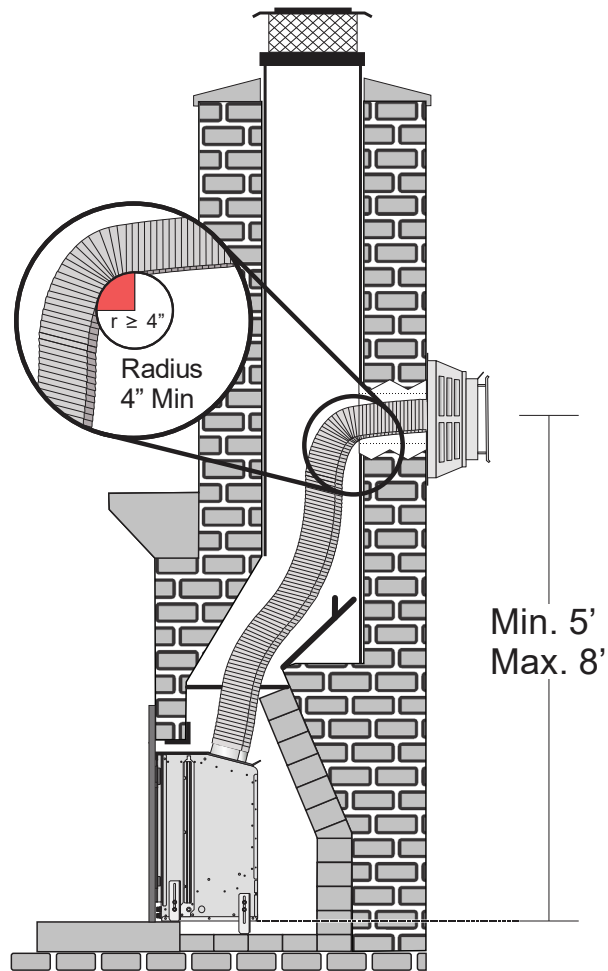

## Co-Linear to Co-Axial Pipe

DuraVent manufactures a vent kit that adapts flexible co-linear venting to co-axial pipe. This can be helpful for situations such as when a damaged masonry chimney top is removed to below the roofline or when an additional story is added to a home and the added height covers the existing masonry chimney height. The DuraVent kits (46DVA-CLTA and 46DVA-34CLTA) are approved for use with Travis Industries gas inserts.

These kits can be purchased from your DuraVent dealer.

Application	DuraVent Part #	DuraVent Stock #
For inserts that use 3" exhaust and 3" intake	46DVA-CLTA	810014742
For inserts that use 4" exhaust and 3" intake	46DVA-34CLTA	810014340

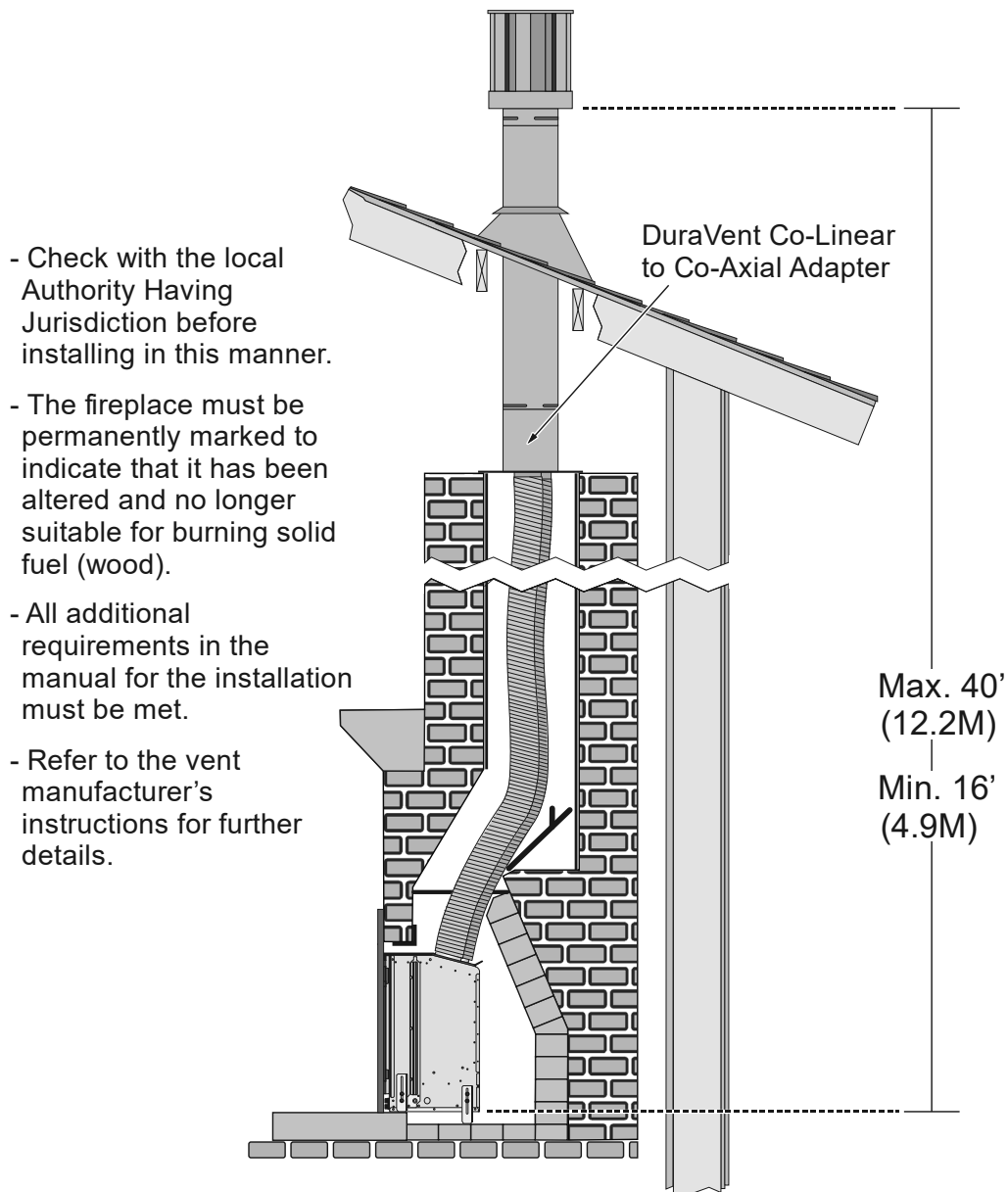



## Glass Frame Removal and Installation



A barrier designed to reduce the risk of burns from the hot viewing glass is provided with this appliance and shall be installed for the protection of children and other at-risk individuals.



If the barrier becomes damaged, the barrier shall be replaced with the manufacturer's barrier for this appliance.



The appliance must be completely cool before removing the glass.



Do not strike or slam the glass.

1. The glass removal tool is located at the upper right of the convection area and may be removed with a ¼" nut driver.



**NOTE:** Replace the tool in this location after removing the glass frame.

14. Remove the glass frame as shown below. The glass frame is held in place with three tabs inserted into three slots at the bottom of the insert.



### Steps for Finalizing the Installation

1. Remove the glass (see page 22).

**NOTE:** If using propane (LP) convert the appliance prior to installing the media.

2. We recommend you purge the gas line at this time (with the glass removed). This allows gas to be detected once it enters the firebox, ensuring gas does not build up.
3. Install the four AA batteries (see illustration below). The AA batteries act as a power backup in case the household (AC) power goes out and are required for operation. Install three AAA batteries into the remote (see illustration below). Synchronize the transmitter to the IFC (see page 30).
4. Make sure the accent light bulbs are in place and work correctly.

**NOTE:** Take care to not touch the bulb with your fingers – use a cloth or paper towel).

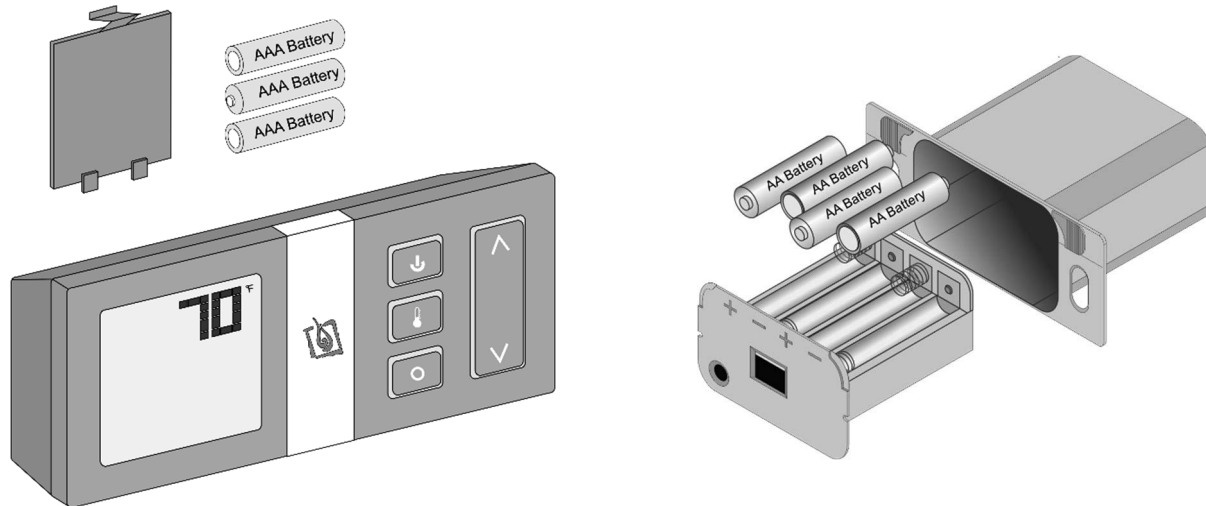

5. Install the media (see the instructions included with the media kit).
6. Replace the glass.
7. Start the heater.
8. Leak test all gas joints.
9. Adjust the air shutter following the directions on the next page.
10. Attach the face following the directions included with the face.
11. Adjust the flame to its highest position - the flames should not contact the top of the firebox. Check the flame on low position. The flames should burn off of each burner hole. If the heater does not work correctly, contact your Travis dealer for a remedy.
12. Give this manual to the homeowner for future reference and fully explain the operation of this heater.

## Air Shutter Adjustment

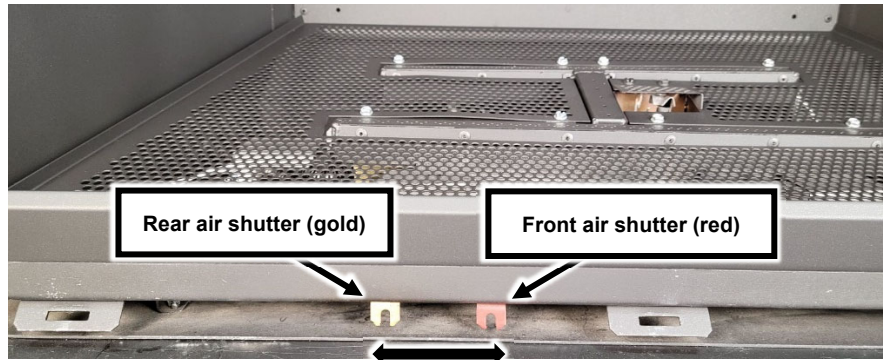

Left = More Air

Let the heater burn for fifteen minutes (make sure the media and glass are in place). The flames should be yellow with no sooting. Adjust the air shutter, if necessary, to achieve the correct looking flame.

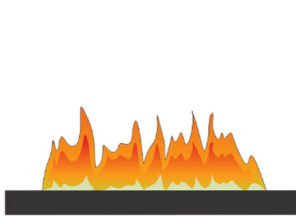

**Correct**

Flames should be blue at the base, yellow-orange on the top.



**Not Enough Air**

If the flames are too tall or sooty on the ends, open the air shutter.

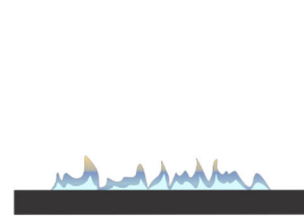

**Too Much Air**

If the flames are all blue and short, close the air shutter.

**Removing Media Tray for Fireback Installation**

1. Remove the (8) screws that secure the media tray to the burners (set the screws aside for re-installation). Lift the media tray and remove it from the firebox.



2. Install the firebacks. See the fireback installation instructions for details.
3. Re-install the media tray assembly after the firebacks are in place.

## Before You Begin

- Read this entire manual before you use your new heater (especially the section "Safety Precautions" on pages 4 & 5). Failure to follow the instructions may result in property damage, bodily injury, or even death.

### Remote Control Warnings

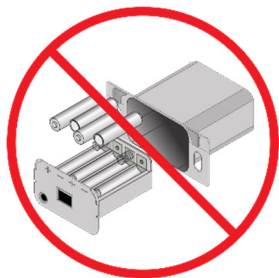

#### **KEEP BATTERIES INSTALLED AT ALL TIMES**

The remote control system requires the batteries to remain in place at all times. Once the batteries are removed, the system may re-start in standing pilot mode. If this occurs when the heater is in Remote Mode, you will not be able to turn the heater off manually from the battery box.

If you need to replace dead batteries, make sure to **turn the appliance off** before removing the batteries.

**NOTE:** If the batteries go dead, the system will operate normally as long as household power (120v AC) is present.



The transmitter and IFC are radio frequency devices. Placing the transmitter in or near metal may severely reduce the signal range.



Turn off the main gas supply to the appliance during installation, maintenance, or in case of remote control malfunction.

### **PROGRAMMING THE REMOTE**

The SIT GSR2 remote may be programmed to disable the thermostat or any of the modes (flame height, blower, light, comfort control, Standing Pilot \*, or auxiliary power input). This allows you to tailor the remote to the appliance.

\* We do not recommend disabling the standing pilot option for our gas appliances. This feature may be recommended for cold regions or installations with sub-optimal venting.

#### **How to Disable/Enable the Thermostat**

- The remote is shipped with the thermostat enabled.
- 1 Remove one battery from the remote.
  - 2 Press and hold the thermostat button while replacing the battery. This will toggle the thermostat function. Repeat this process to toggle the thermostat function to the desired setting.

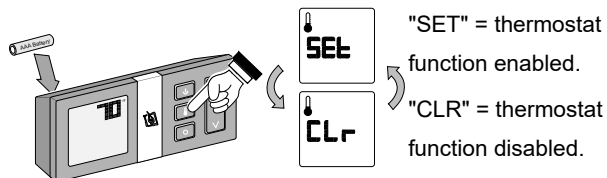

#### **How to Disable/Enable Modes (Light, Blower, etc.)**

- The remote is shipped with all modes enabled.
- 1 Remove one battery from the remote.
  - 2 Press and hold the on/off button and mode button while replacing the battery.

**Keep the on/off button depressed during the following steps.**

- 3 While keeping the on/off button depressed, press and release the mode button until the mode that needs to be changed is illuminated.
- 4 With the desired mode illuminated (see illustration to the right), press the "up" or "down" button to activate or clear the mode being addressed. Make sure to keep the on/off button depressed during this process.
- 5 Release the on/off button to complete programming.

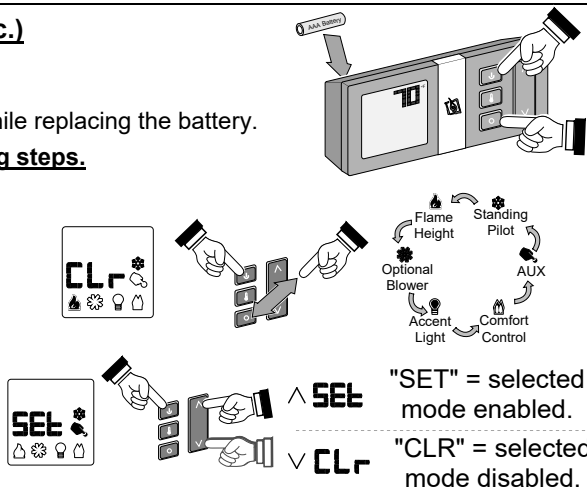

## Remote Set-Up

### Verify the Switch is on “REMOTE”

The battery holder has a switch built into it (see **Figure 1**). This switch must remain in the REMOTE position for the remote to operate.

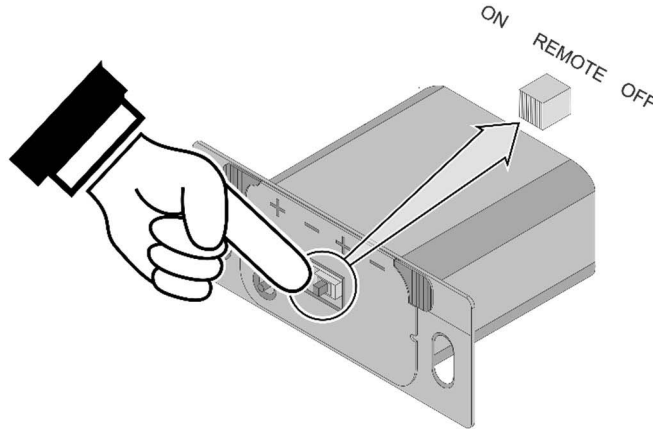

Figure 1

### Synchronize the Transmitter to the IFC

The transmitter will need to be synchronized to the IFC (Integrated Fireplace Control) before the remote will work correctly. Synchronizing is done in the following two steps below (see **Figure 2**):

15. Press the PRG (Program) button on the battery box (IFC will beep 3 times).
16. Press the “ON” button on the transmitter (IFC will beep 3 times).

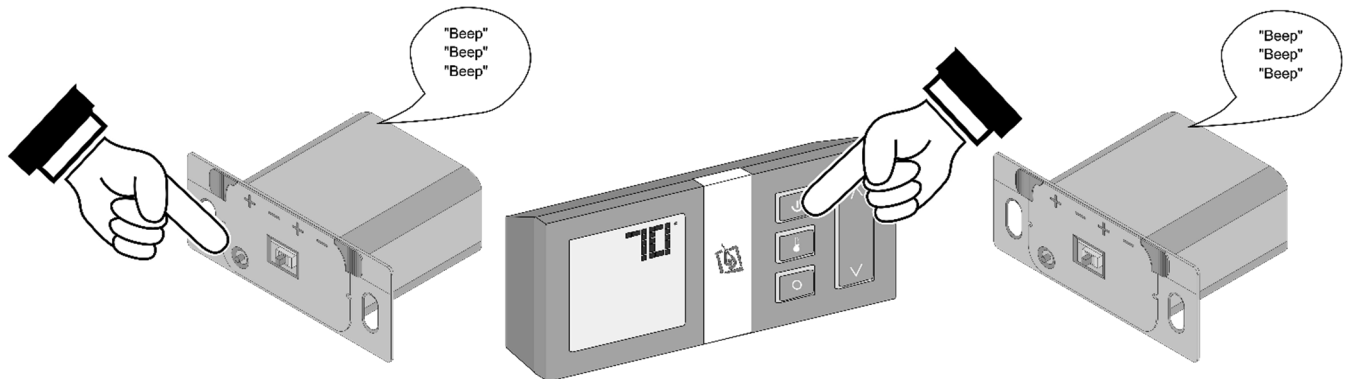

Figure 2

**NOTE:** If power is cut off to the IFC for an extended period, you may need to re-synchronize the remote.

### **Clearing the System Memory**

This appliance uses an Integrated Fireplace Control (IFC) to store the unique code for the remote control. If you wish to clear the system memory, **MAKE SURE GAS IS TURNED OFF TO THE APPLIANCE** then press the PRG (Program) button for 10 seconds. The pilot will start to spark repeatedly, signifying all system memory has been cleared. The system will return to its original configuration: a remote will need to be synchronized; and, the system will operate under continuous pilot mode.

## Starting the Heater for the First Time

- Burn the heater at a high setting with the blower off for an extended period (up to 48 hours). This will cure the painted surfaces. **Fumes** from the paint curing and oil burning off the steel will occur. This is normal. We recommend opening a window to vent the room.
- **Condensation** may appear on the glass each time you start the heater - this is normal.
- **Blue Flames** will occur on the heater when it first comes on. After fifteen minutes the flames will turn a more realistic yellow and orange color.
- Verify the batteries are installed (see page 38).

## Location of Controls

Most features will be controlled by the included remote.

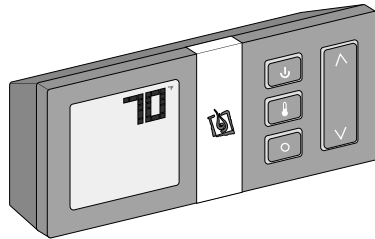

## Direct Operation

The fireplace may be directly operated from the battery holder (accessed by removing the face). The three positions are below (see Figure 3):

**ON (all the way left)**– Burner turns on (regardless of transmitter settings).

**OFF (all the way right)** – Burner turns off (regardless of transmitter settings).

**REMOTE (middle position)** – Burner is controlled by the transmitter.

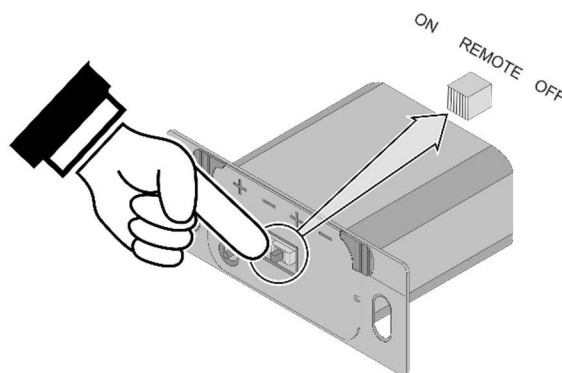

Figure 3

**NOTE:** When the battery holder switch is turned to ON or OFF, the mode settings (Flame Height, Comfort Control) will remain in the same state as before the switch was moved (i.e.: the IFC “remembers” the last setting). If you wish to adjust the mode settings use the transmitter mode button to adjust the settings. The thermostat and burner on/off operating functions will not work on the transmitter.

## Intermittent/Continuous Pilot

This heater may run with the pilot continuously running or in intermittent mode. For most homeowners, the intermittent mode is preferred (this saves fuel, doesn't give off un-needed heat). However, in some situations, the homeowner may prefer to switch the heater to continuous pilot. The most typical reasons for switching to continuous pilot are:

- Very Cold Conditions – in very cold conditions you may notice that the burner does not light quickly, and the flames lift off the burner. If this is the situation, we recommend you switch to continuous pilot. This will create a slight draft in the vent, allowing for the burner to light quickly and draft correctly.
- Excessive Condensation on Glass After Startup – certain installations may encounter excessive fogging on the window after startup (not just the first time the heater was started). This is an aesthetic condition that may be remedied by switching the heater to continuous pilot.
- Cold Glass or Heater Front – in very cold conditions you may notice that the heater front and glass become very cold. To remedy this, switch the heater to continuous pilot.
- Frequent On / Off Operation – if you are frequently turning the heater on and off, you may wish to leave it in continuous pilot. This allows the burner to turn on more quickly, without pilot ignition delay.

### Switching from Intermittent (IPI) to Continuous Pilot (CPI)

The pilot mode on this appliance is adjusted using the remote. With the remote in the off position (thermostat off, manual off), follow the directions below to adjust the pilot mode.

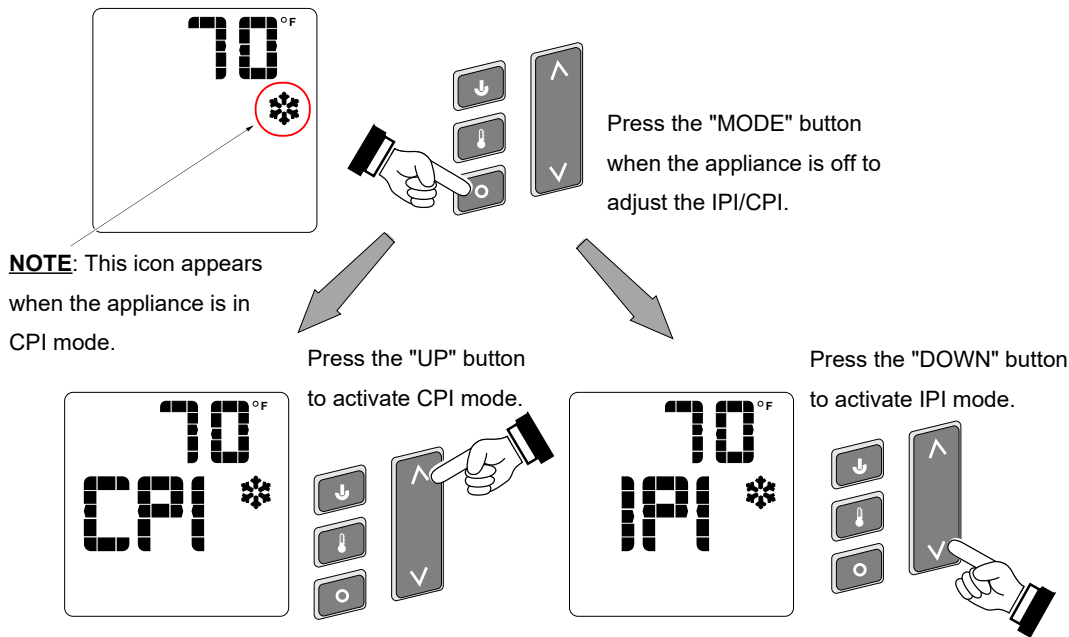

Figure 4



## ***Pilot Fuel Conservation Timer***

### **7 Day Pilot Shutoff Timer (applies to units in CPI mode only)**

This appliance may be equipped with a 7-day pilot shutoff timer. This timer helps conserve fuel and save money by turning the pilot off when the appliance is not used for 7 days (this timer is mandated in certain areas for conservation purposes). This applies only when the unit is in CPI (Continuous Pilot Ignition) mode. If the unit is in IPI (Intermittent Pilot Ignition) mode, the timer does not apply.

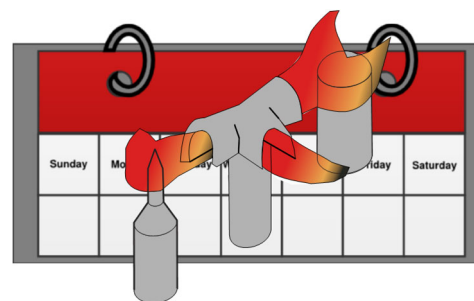

When in CPI mode the pilot will remain lit as long as the burner is engaged within a 7-day window. Each time the burner is turned on the 7-day timer resets. If the burner is not engaged within the 7-day window, the pilot will automatically revert to IPI mode and turn off to conserve fuel.

### **To switch back to CPI, simply:**

GSB2 Units: toggle the IPI/CPI switch to IPI, then back to CPI.

GSR2 Units: use the remote to toggle from IPI mode, then back to CPI mode.

To prevent the need to reset the pilot mode during the heating season, we have listed a few strategies below:

### **Option 1: Remember to periodically turn on the heater during the heating season**

If you use your heater for supplemental heat, this may be the best solution. Set a specific time, once or twice per week (e.g. 5 pm on Tuesday & Friday) to turn the heater on for a few minutes. This will reset the timer and prevent the need to restart the pilot.

### **Option 2: Use a thermostat**

GSR Units: Use the thermostat included with the appliance

GSB Units: Consult your dealer for thermostats compatible with your appliance.

The use of a thermostat will keep the room at a constant temperature and will, in most cases, keep the heater working throughout the heating season. Light the pilot at the beginning of the heating season and set the thermostat to the desired room temperature. As long as the outside temperature does not rise excessively, for seven days or more, the pilot will continue to operate.

### **Option 3: Use a programmable thermostat (GSB2 Only)**

A programmable thermostat may be set to turn on, once per week, to a high temperature for a short time. This will reset the 7-day timer and allow the heater to operate without having to restart the pilot.

## Remote Operation

When the switch on the battery holder is set to “REMOTE” the transmitter operates the fireplace. Once you understand how the transmitter works, you will be able to operate your fireplace quickly and easily.

### Display Overview

The transmitter display has four main sections (see **Figure 5**).

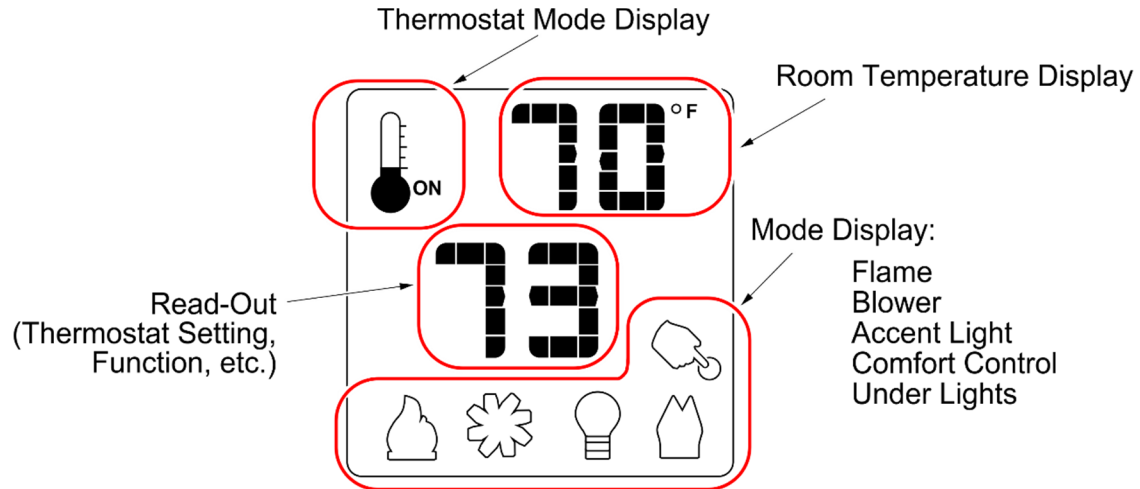

Figure 5

### Listen for the “Beep”

Each time you press a button on the transmitter that controls the fireplace, a “beep” will come from the Integrated Fireplace Control (IFC). When you change thermostat target settings the IFC will not beep.

**NOTE:** When the batteries start to get low, the IFC will beep twice whenever a button is pressed. When the batteries are nearly depleted, the IFC will no longer beep. See “IFC Batteries” on page 38).

**Manual On-Off / Smart Thermostat / Standard Thermostat**

Use the thermostat button to cycle through the three thermostat settings (see Figure 6).

Look here for the thermostat setting.

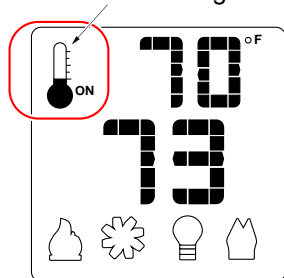

Press the thermostat button to cycle through the thermostat settings.

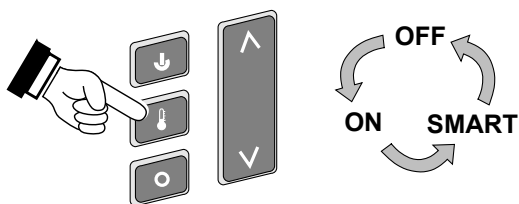

Figure 6

- **MANUAL ON/OFF** – The burner will turn on and off using the remote (see Figure 7). Press the On/Off button to control the burner. When off, the display will only show the current temperature.

When in manual setting, the word "OFF" will appear here.

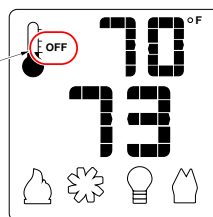
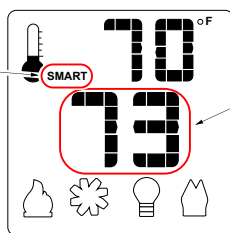

Figure 7

- **SMART THERMOSTAT** – While in smart thermostat, the transmitter will control the burner to achieve the target temperature (see Figure 8 below). Flame height will be adjusted up or down to allow operation without turning the burner on and off (also called “smart modulation”). To adjust the target temperature, press the UP and DOWN buttons until a suitable temperature is achieved.

When in smart thermostat setting, the word "SMART" will appear here.



This is the target temperature on the read-out. Use the up or down buttons to adjust the target temperature.

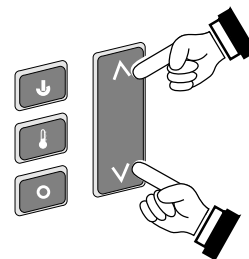
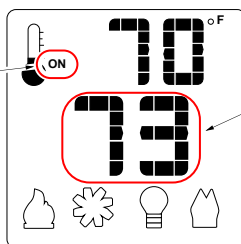

Figure 8

- **STANDARD THERMOSTAT** - While in standard thermostat setting, the transmitter will turn the burner on and off to achieve the target temperature (see Figure 9 below). To adjust the target temperature, press the up and down buttons until a suitable temperature is achieved.

When in standard thermostat setting, the word "ON" will appear here.



This is the target temperature on the read-out. Use the up or down buttons to adjust the target temperature.

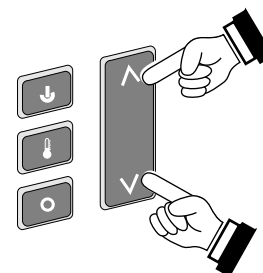

Figure 9

**NOTE:** If the transmitter batteries go dead while in thermostat setting (standard or smart), the appliance will shut off after approximately 24 hours.

**Mode Controls (Flame, Blower, Light, Comfort Control, Under Light)**

Use the mode button to cycle through the five mode controls (see Figure 10 below).

Press the mode button to cycle through the mode settings.

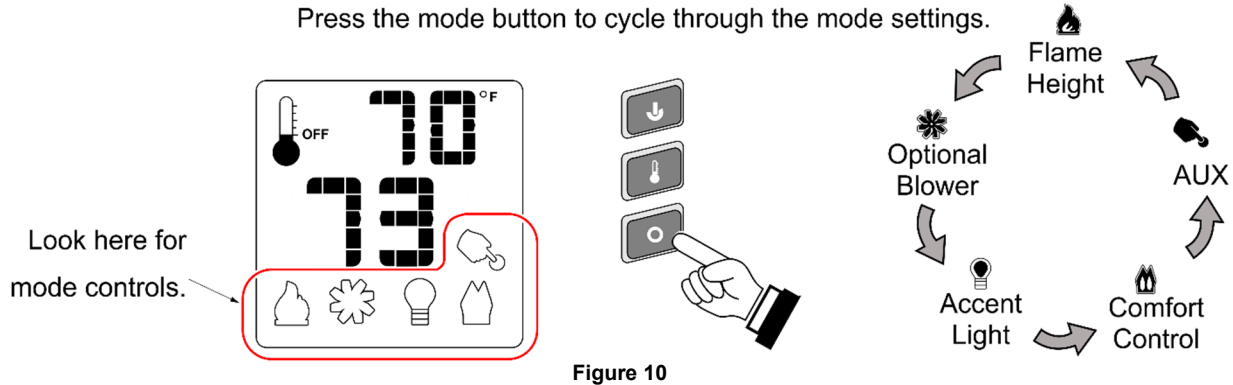

**Flame Height**

Flame height may be controlled using the UP and DOWN buttons when in Flame Height Mode (see Figure 11 below). The center display will display the 7 settings, from “OFF” to “HI” for full on.

**NOTE:** Flame height may not be adjusted if operating in Smart Thermostat setting.

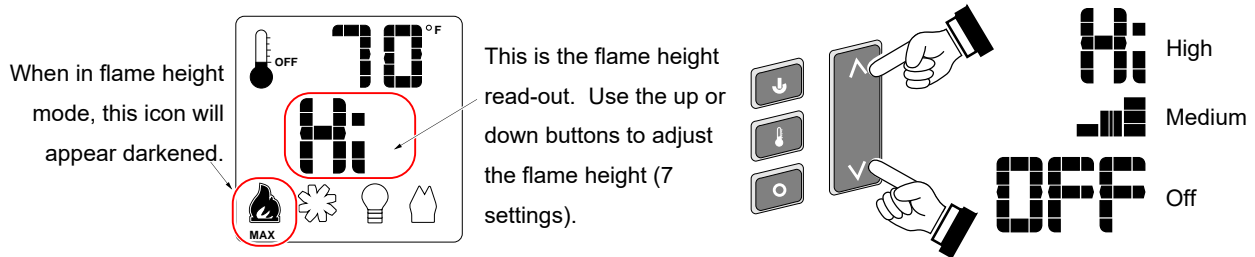

**Blower Speed**

The blower may be controlled using the up and down buttons when in Blower Speed Mode (see Figure 12). The center display will display the 7 settings, from “OFF” to “HI” for full on.

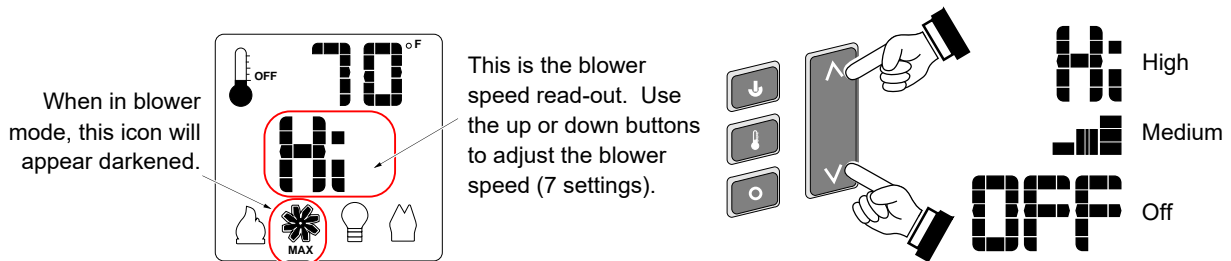

**MANUAL MODE – BLOWER OPERATION**

When in Manual Mode the blower will remain on, even if the burner is turned off and the heater cools. Either manually turn the blower off, or turn off the heater by pressing the On/Off button.

**Mode Controls - continued**

**Accent Light**

The Accent Light (night light) inside the heater may be turned on and off using the up and down buttons when in Accent Light Mode (see illustration below). The center display will display the 7 settings, from “OFF” to “HI” for full on.

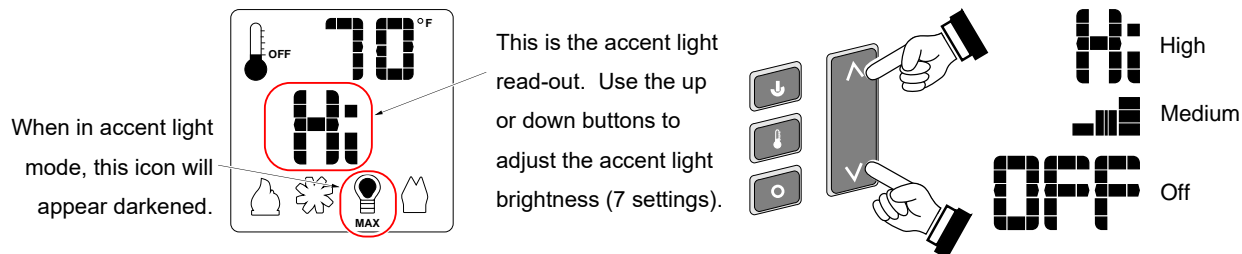

**HINT:** If you wish to leave the accent light on while turning the burner off, adjust the Flame Height to “OFF” (see above).

**Comfort Control (rear burner)**

The comfort control (rear burner) may be turned on and off using the up and down buttons when in Comfort Control Mode (see illustration below). The center display will display either “ON” or “OFF”.

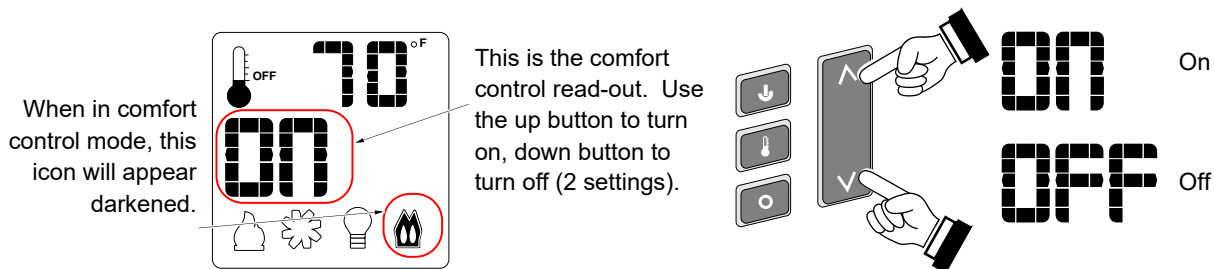

**Under Light (AUX)**

The Under Light may be turned on and off using the up and down buttons (see illustration below). You can adjust the brightness of the Under Light using the built-in rheostat.

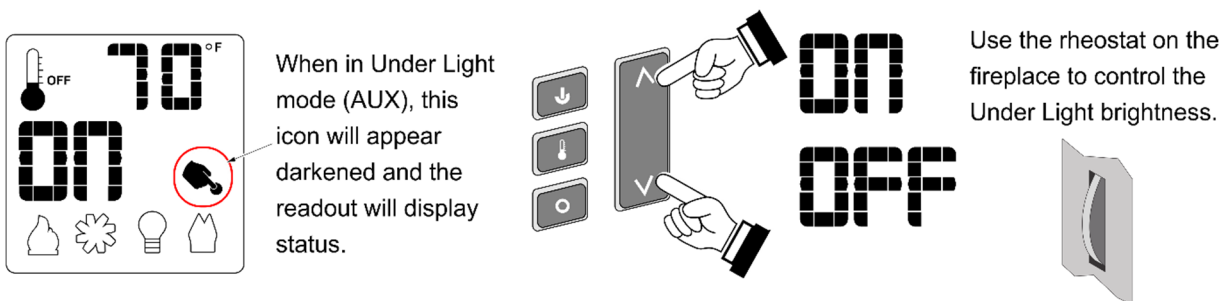

**Display Fahrenheit or Celsius**

- With the system in the “OFF” position, press both the MODE and THERMOSTAT buttons simultaneously to toggle between Fahrenheit (F) and Celsius (C).

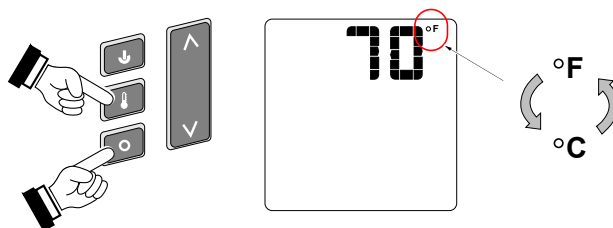

## Low Battery Indicator

### Transmitter Batteries

The transmitter has a battery-level indicator. When it indicates low battery voltage (see Figure 13 below), install three new AAA alkaline batteries into the transmitter (see “Transmitter Battery Installation” on page 38).

Low Battery Indicator

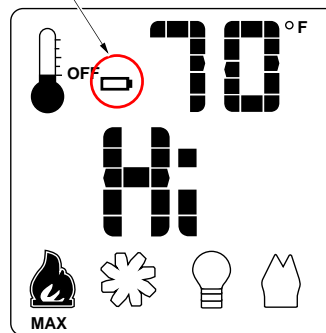

Figure 13

### IFC Batteries

The IFC (Integrated Fireplace Control) will “beep” twice when a transmitter button is pressed when the batteries are low. Install four new AA alkaline batteries into the battery box when this occurs (see “Battery Installation” on page 38). In applications where the appliance is required to provide heat, we recommend replacing the batteries before each heating season.

## Battery Replacement

### Battery Installation

Install four AA batteries into the battery holder (see Figure 14 below). These batteries act as a power backup in case the household (AC) current goes out.

### Transmitter Battery Installation

Install the three included AAA batteries into the remote.

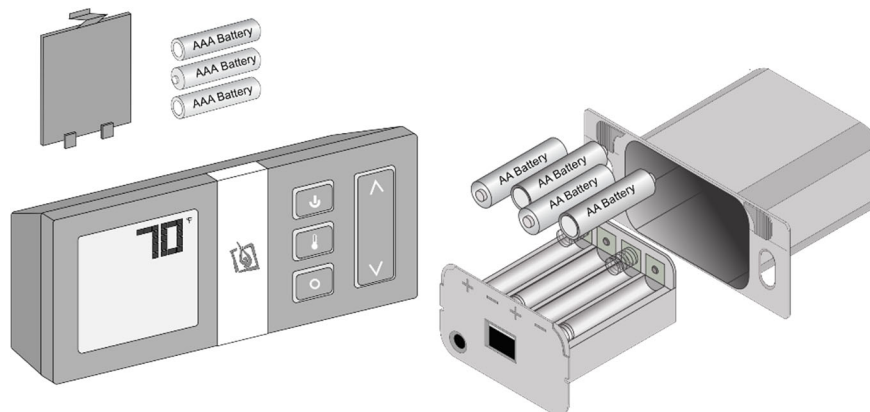

Figure 14

## Power Outages

The remote will work if the household current (AC power) is disconnected. The batteries inside the battery box will continue to power the heater but the accent light(s) and blower will not operate.

### Childproof Feature

The childproof feature disables the control buttons, preventing unwanted use of the remote.

- Press both the MODE and UP buttons simultaneously to turn this feature on and off (see Figure 15 below).

**HINT:** This feature is especially useful while using the thermostat setting.

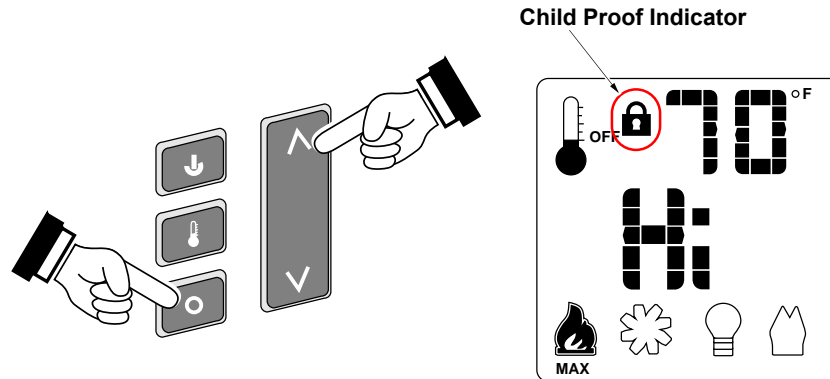
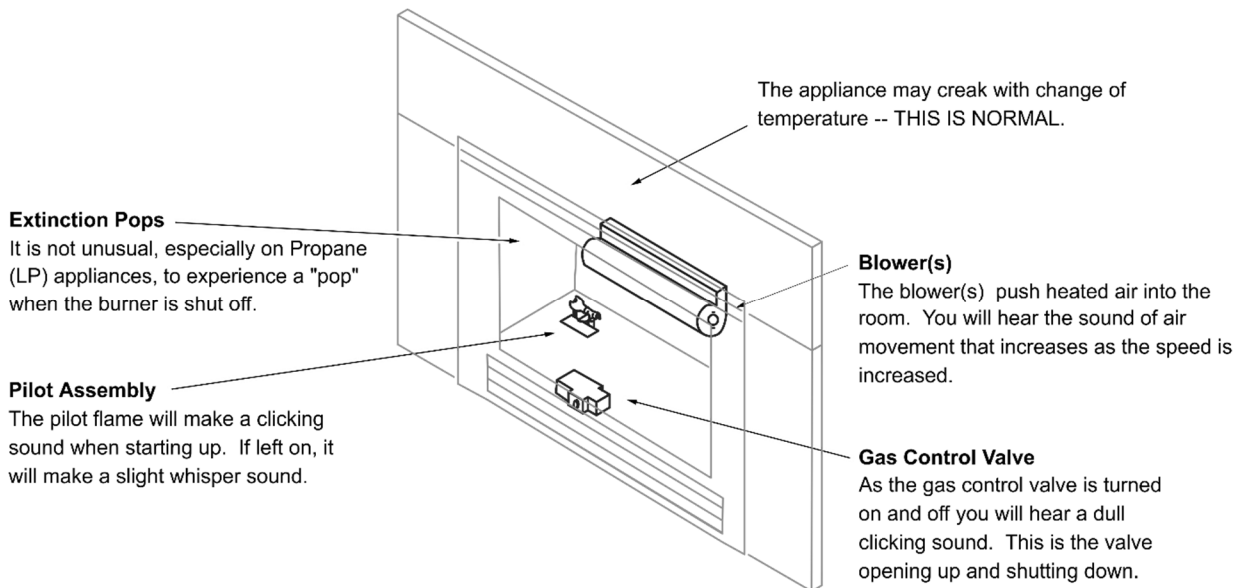

Figure 15

### Normal Operating Sounds



### Normal Operating Odors

This appliance has several areas that reach high temperatures. Dust or other particles on these areas may burn and create an odor. This is normal during start-up. You may notice the smell is more acute if the appliance was left idle for a long period.

**DANGER HIGH VOLTAGE:** Disconnect power before attempting maintenance or repair.

## Maintaining Your Heater's Appearance

Fingerprints or other marks left on the optional plated surface may become etched in place if they are not wiped clean prior to turning the heater on. Clean the plated surfaces with denatured alcohol and a soft cloth (with the heater cool). Other cleaners may leave a film that may become etched into the surface.

## Accent Light Replacement

The accent lights in your heater provide additional lighting. The bulbs will burn out over time. To replace, follow the directions below:

1. Shut off gas to the heater and let it cool for 15 minutes.
2. Remove the glass (see page 25) and media.
3. Replace the halogen bulbs with the following bulbs:

**NOTE:** Take care to not touch the bulbs with your fingers – use foam packing or a paper towel to handle the bulbs:



**35 Watt 120 Volt T4 Halogen Bulb (GY6.35 Base)**

## Upper Accent Lights

The upper accent light can be accessed by removing the 4 screws with a 1/4" nut driver, as shown below.



The upper accent light assembly drops down to expose the accent light.



When replacing the assembly, carefully insert the wiring into this cavity to ensure the wiring is not pinched.

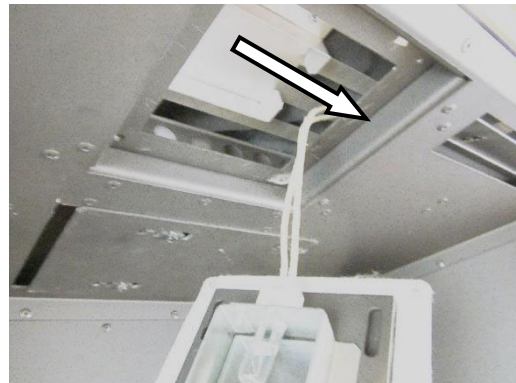
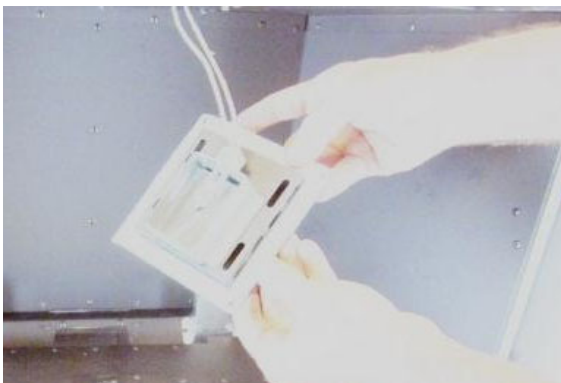

The upper accent light may now be accessed.



Loosen the two screws nearest the bulb to disengage the bulb from the holder. Remove the bulb from the holder. Replace the bulb, making sure not to touch the bulb with your fingers (grasp the bulb with the bulb packaging or a paper towel). Tighten the screws until the bulb is secure (do not over-tighten; this may damage the electrical contacts on the bulb).

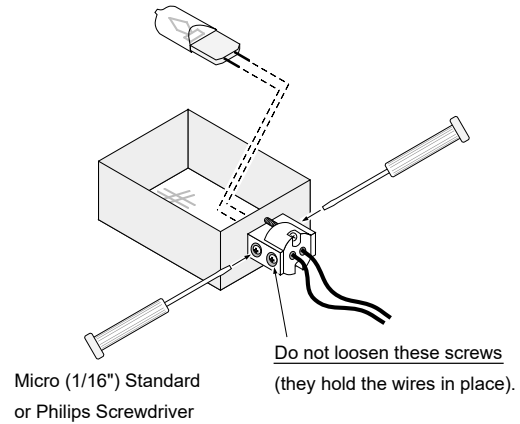

## ***Under Light Bulb Replacement***

The Under lights in your insert provide additional lighting. The bulbs will burn out over time. Replace the halogen bulbs with the following bulbs:

**35 Watt 120 Volt T4 Halogen Bulb (GY6.35 Base)**

To replace, follow the directions below:

1. Shut off gas to the Insert and let it cool for 15 minutes.
2. Remove the glass assembly (see page 25).
3. Remove glass media from the media tray.



4. Use a 1/4" nut driver to remove the (8) media tray attachment screws that secure the tray to the burners (set the screws aside for reinstallation).

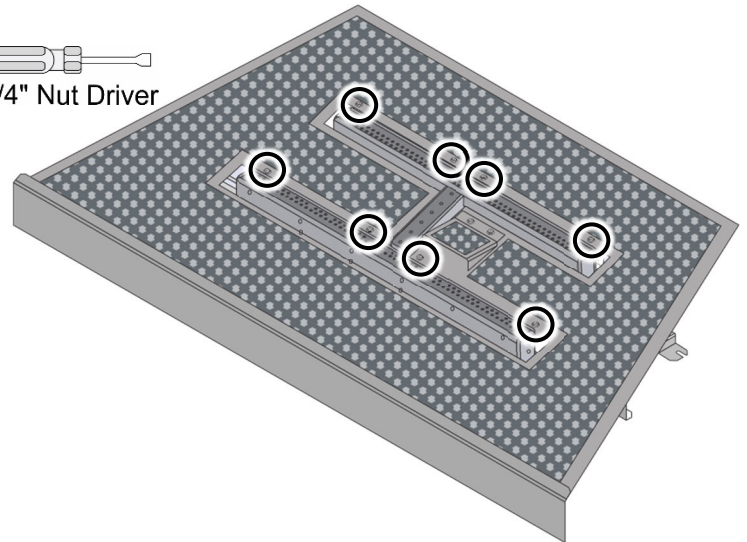

5. Lift the media tray up and out of the firebox.

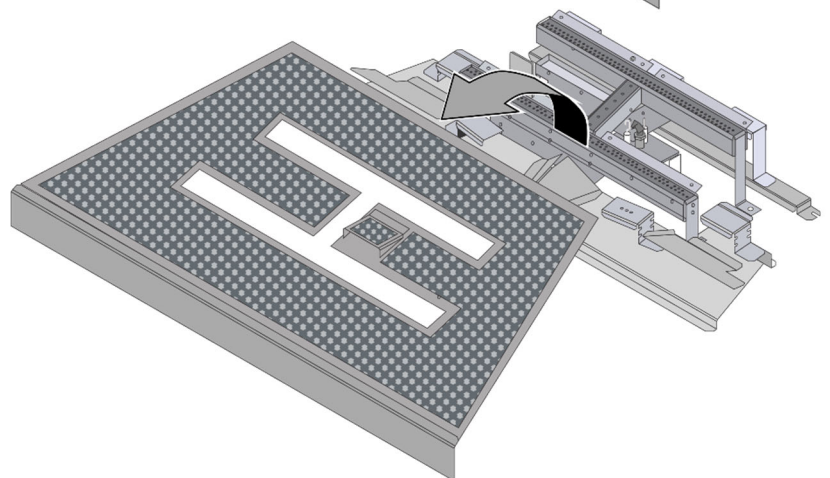

There are (7) bulb sockets in this appliance (see illustration).

**NOTE:** It may be easier to access the (3) rear sockets by removing the burners (see “Burner Removal” section for details).

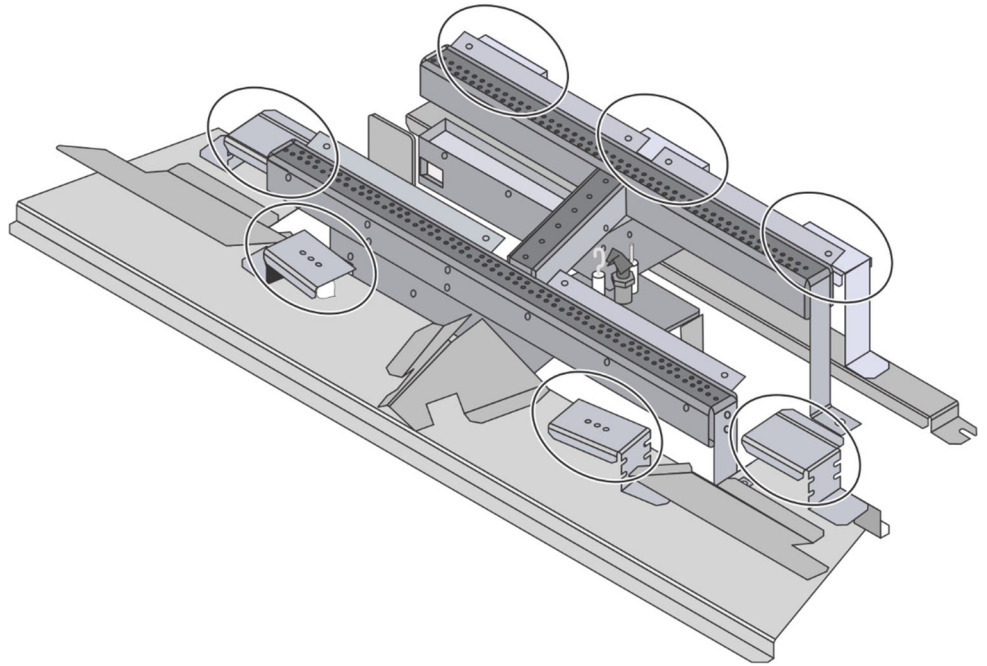

6. Remove the bulbs from the socket by pulling the bulbs directly away from the socket (do not twist).

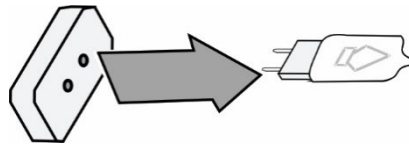

7. Gently insert the pins on the replacement bulb into the holes on the socket.

**NOTE:** Take care to not touch the replacement bulbs with your fingers – use foam packing or paper towel to hold the bulb

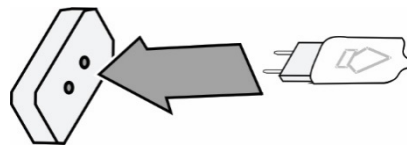

8. Return the fireplace to its correct configuration.

## Yearly Service Procedure

**WARNING:** Failure to inspect and maintain the stove may lead to improper combustion and a potentially dangerous situation. We recommend the following procedures be done by a qualified technician.

- Shut off gas to the fireplace and let it cool for 15 minutes. Remove the glass. Inspect and operate the pressure relief mechanism to verify relief mechanisms are free from obstruction to operate.
- Clean glass window with a suitable fireplace glass cleaner. Abrasive cleaners must not be used. Be careful not to scratch the glass when cleaning.
- Vacuum and clean any debris in the firebox.
- Check all accessible gas-carrying tubes, connections, pipes, and other components for leaks.
- Inspect the burner and firebox. Make sure the burner is not warped, cracked, or damaged. Check the firebox and area around the pilot to make sure there is no damage. Inspect primary air openings for blockage. If any problem is found, discontinue use and contact your dealer for service.
- Inspect the area behind the access door; clean if necessary. Check the gas control valve and the gas lines. If damage is found, discontinue use and contact your dealer for service. Clean the air channels, ducts, and blower (if applicable)
- Inspect vent and vent termination for sooting, obstructions, or damage. Make repairs as needed. Remove any debris or vegetation near the vent termination. Contact your dealer if any sooting or deterioration is found near the vent termination.
- Reinstall the glass assembly. If the glass is damaged, replace it. Make sure the gasket along the perimeter of the glass contacts the face of the firebox and forms an airtight seal. If it does not, re-align or replace the gasket to ensure an airtight seal.
- Turn the pilot flame on (continuous pilot). It should touch approximately 3/8" of the top of the flame sensor (see below). If it does not, contact your dealer.

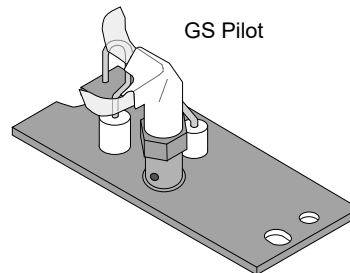

- Start the main burner. Inspect and ensure the lighting of the main burner occurs within 4 seconds of the main gas valve opening.
- Test the flame failure response time of the flame safety system. It must de-energize the safety shutoff in no more than 30 seconds.
- After 15 minutes, the flames should be orange/yellow and not touch the top of the firebox. If the pilot or main burners do not burn correctly, contact your dealer for service. Monitor blower operation

**Troubleshooting Table**

<b>Problem:</b>	<b>Possible Cause:</b>	<b>Don't Call for Service Until You:</b>
<b>Main Burners Will Not Start</b>	The battery box switch is turned to "OFF"..... The remote control is not working correctly..... The thermostat is disconnected or set too low..... No propane in the tank.....	Turn the battery box switch to "ON". See the remote control instructions. See "Thermostat Operation". Check Tank Level.
<b>Appliance Beeps</b>	<u>Heater beeps once:</u> The heater beeps once whenever a button on the remote is pressed..... <u>Heater beeps twice:</u> The heater beeps twice whenever a button on the remote is pressed.....	THIS IS NORMAL  The power backup batteries are low. Replace the 4 AA batteries in the battery box (see page 38).
<b>Thermostat Does Not Work</b>	The battery box switch is turned to "OFF" or "ON". The thermostat is set too low.....	Turn the battery box switch to "REMOTE" Check thermostat
<b>Blower Does Not Work</b>	The fireplace is not getting electricity..... The fireplace is not up to temperature..... The blower fuse may be blown.....	Check the breaker switch Let the fireplace burn for 10 minutes Replace the fuse. See fuse location below.
<b>Fireplace Will Not Distribute Heat</b>	The fireplace is not getting electricity..... The fireplace is not up to temperature.....	Check the breaker switch. Let the fireplace burn for at least 15 minutes.
<b>Flames Are Too Blue</b>	The fireplace has just been started..... Improper air shutter adjustment.....	This is normal - see "Starting the Fireplace for the First Time". Adjust Air Shutter - contact your dealer.
<b>Rear Flames Are Too Short (Under 6")</b>	The flame height may be turned too low.....	Turn the flame height to "HI" - See "Adjusting the Flame Height".
<b>Thin Layer of Soot Covers the Glass</b>	The media or coals are placed incorrectly..... Improper air shutter adjustment.....	See "Media Installation". Adjust air shutter - contact your dealer.
<b>Accent Light Does Not Work</b>	The bulb may be burned out..... The accent light fuse may be blown. ....	See "Accent Light Replacement" on page 40 Replace the fuse. See fuse location below.

Location of fuses (3 amp) in the lower right corner under the firebox:

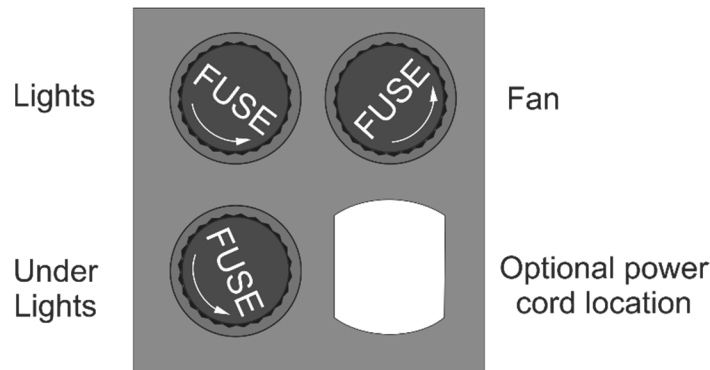

## Wiring Diagram

**CAUTION:** Label all wires prior to disconnection when servicing controls. Wiring errors can cause improper and dangerous operation.

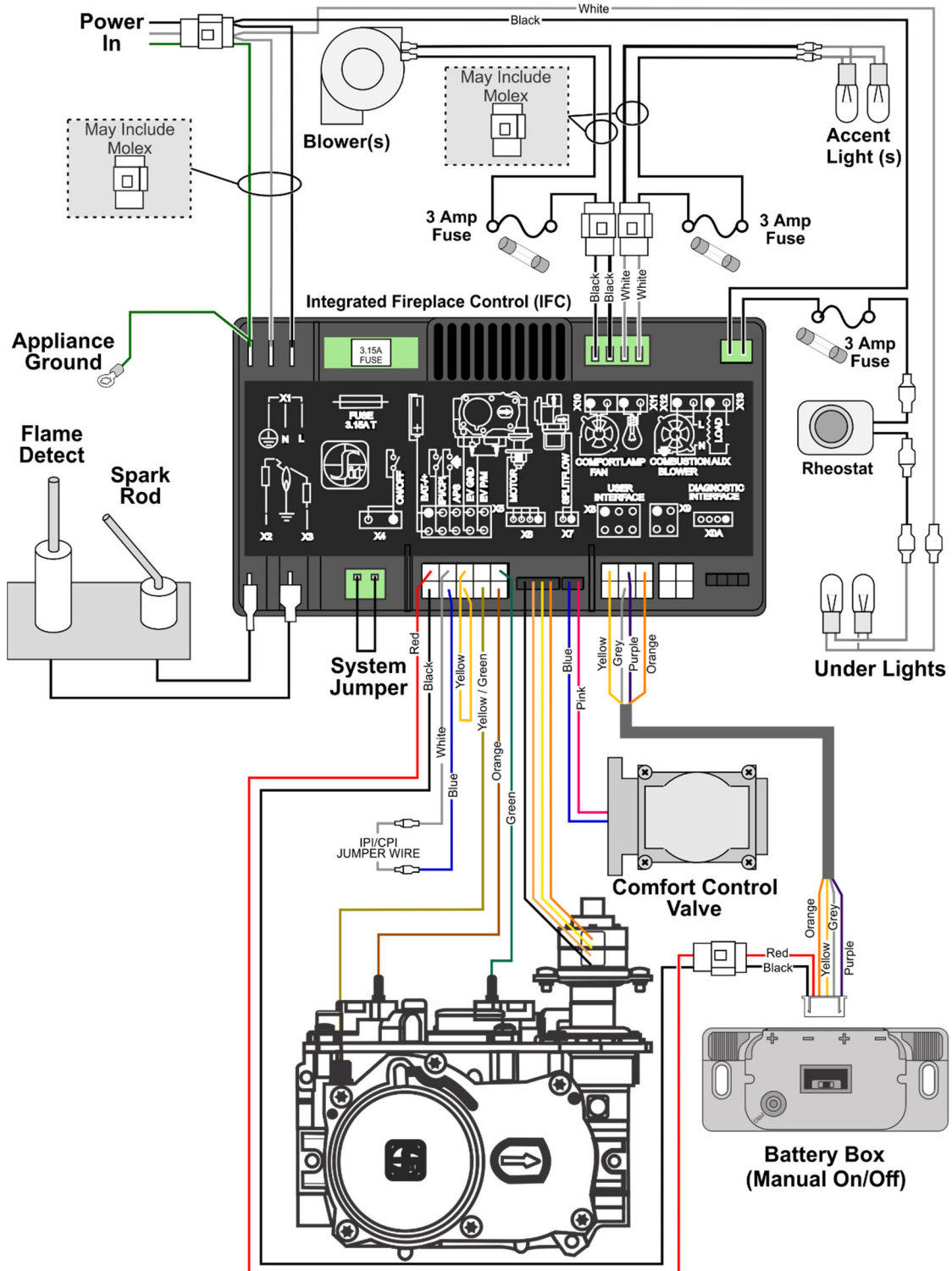

## Replacement Parts

---

**Contact your local Travis Industries Dealer for a Replacement Parts**

**Caution:** Use only Travis Industries replacement parts. Do not use substitute materials.

**Warning:** Do not operate the appliance with the glass front removed, cracked, or broken. Replacement of the glass should be done by a licensed or qualified service person.

Description	SKU#
GAS CONTROL VALVE, NG w/ STPR. MTR.	250-01612
CNTRL MODULE	250-03826
PILOT ASSY PSE 2-WAY	250-05210
GLASS w/GASKET	250-02549
GLASS TOOL	250-02555
LIGHT BULB, HALOGEN 5PK	250-00022
ORIFICE, BURNER - No. 43	250-00398
ORIFICE, BURNER - No. 46	250-00401
ORIFICE, BURNER - No. 55	250-00409
ORIFICE, BURNER - No. 56	250-00406
REMOTE, BLK WALL-MOUNT	250-03262
BLOWER ASSY, LF	250-05136
BLOWER ASSY, RT	250-05135

## Safety Label

The safety (listing) label is attached to the operating tag (chained to the heater near the gas control valve). A copy is shown below.

Minimum Clearances to Combustibles			
Side of Insert to Adjacent Wall	6" (153mm)	Base of Insert to Mantel	See Owner's Manual
Hearth Extension in Front	0" (0mm)	Base of Insert to Top Facing	See Owner's Manual
Hearth Extension to Sides of Insert	0" (0mm)	Flue Vent	See Owner's Manual
		Enclosure Clearances	See Owner's Manual

**FAN TYPE VENTED CIRCULATOR**

Blower Electrical Rating: 120 VAC, 1.8 Amps, 60 Hz, 205 Watts

Part No. 250-05135 / 250-05136 fan or blower assembly may be used. For use with factory barrier (see "Finalizing the Installation" in the owners manual for part numbers). Follow installation instructions.

Input Rate on "HI" (BTU/Hr)	PROPRANE	N.G.	PROPRANE	N.G.
39,000	39,000	39,000	Minimum Inlet Pressure (inches W.C.)	11"
9,000	9,000	12,000	Maximum Inlet Pressure (inches W.C.)	13"
#56	#46	#43	Manifold Pressure on "HI" (inches W.C.)	11"
#55	#43			3.5"

This appliance is equipped for use only at altitudes 0-2,000 feet (0-610m) in the USA. In Canada, 0-4,500 feet (0-1370m). For altitudes above 2,000 feet, the vent configuration, orifice, or combination of both may need to be changed. See owner's manual for information on making these changes.

**MANUFACTURE DATE:**

<input type="checkbox"/> 2022	<input type="checkbox"/> Jan.	<input type="checkbox"/> Apr.	<input type="checkbox"/> Jul.	<input type="checkbox"/> Oct.
<input type="checkbox"/> 2023	<input type="checkbox"/> Feb.	<input type="checkbox"/> May	<input type="checkbox"/> Aug.	<input type="checkbox"/> Nov.
<input type="checkbox"/> 2024	<input type="checkbox"/> Mar.	<input type="checkbox"/> Jun.	<input type="checkbox"/> Sep.	<input type="checkbox"/> Dec.

**Manufactured by:**



**TRAVIS INDUSTRIES**  
**HOUSE OF FIRE**  
12521 Harbour Reach Drive  
Mukilteo, WA 98275  
www.travisproducts.com

**CAUTION: Do not operate this appliance with glass removed, cracked or broken. Replacement of the panel(s) should be done by a licensed or qualified service person.**

1380



**616 GSR2**  
**EG / Mod-Fyre**  
Vented Gas Fireplace Heater

Control No. 4900515

Certified to: ANSI Z21.88/CSA 2.33:19 "Vented Gas Fireplace Heater", CSA 2.17-2017 "Gas-Fired Appliances for Use at High Altitudes". Refer to the Intertek Directory of Building Products (<https://bpdirectory.intertek.com>) for detailed information.

This appliance must be installed in accordance with local codes, if any; if none, follow the National Fuel Gas Code, ANSI Z223.1/NFPA 54, or Natural Gas and Propane Installation Codes, CSA B149.1.

This appliance must be installed in accordance with the current Standard CAN/CSA Z240 MH, Mobile Housing, in Canada or with the Manufactured Home Construction and Safety Standard, Title 24 CFR, Part 3280, in the United States, or when such a standard is not applicable, ANSI/CSBCS A225.1/NFPA 501A, Manufactured Home Installation Standard.

This vented gas fireplace heater is equipped at the factory for use with natural gas. If conversion to propane (LP) is desired, the optional factory conversion kit must be used. Part No. 250-05216 may be used.

This appliance is only for use with the type(s) of gas indicated on the rating plate and may be installed in an aftermarket, permanently located, manufactured home (USA only) or mobile home, where not prohibited by local codes. See owner's manual for details. This appliance is not convertible for use with other gases, unless a certified kit is used.

This vented gas fireplace heater is not for use with air filters.

Keep burner and control compartment clean. See installation and operating instructions accompanying appliance.

**THIS APPLIANCE MUST BE PROPERLY CONNECTED TO A VENTING SYSTEM IN ACCORDANCE WITH THE MANUFACTURER'S INSTALLATION INSTRUCTIONS.** Use only approved co-linear direct vent system to vent this appliance to the exterior. See owner's manual for approved brands of venting.

If the vent-air intake system is disconnected for servicing or any other reason, it must be resealed and / or reinstalled.

**WARNING:** Improper installation, adjustment, alteration, service or maintenance can cause injury or property damage. Refer to the owner's information manual provided with this appliance. For assistance or additional information consult a qualified installer, service agency or the gas supplier.

**CATEGORY 1 VENTED GAS FIREPLACE HEATER - NOT FOR USE WITH SOLID FUEL**

Register your TRAVIS INDUSTRIES, INC. Limited 7 Year Warranty online at [traviswarranty.com](http://traviswarranty.com). TRAVIS INDUSTRIES, INC. warrants this gas appliance (appliance is defined as the equipment manufactured by Travis Industries, Inc.) to be defect-free in material and workmanship to the original purchaser from the date of purchase as follows:

Check with your dealer in advance for any costs to you when arranging a warranty call.  
 Mileage or service charges are not covered by this warranty. This charge can vary from store to store.

Component	Years 1 & 2 Parts & Labor	Years 3 Through 5 Parts & Labor	Years 6 & 7 Parts Only
<b>Burner Assembly</b> Burner Pan Assembly, Air Shutter Assembly, Main Burner Orifice	✓		
<b>Electrical Assembly (within heater structure):</b> Wiring harness, snap discs, rheostat speed control, blowers, etc.	✓		
<b>Gas Control Assembly</b> Adjustable control valve, fireplace controller, pilot assembly, and pilot wiring	✓		
<b>Glass</b> Glass (breakage from thermal shock)	✓		
<b>Media</b> Log Set, Stones, etc.	✓		
<b>Gold, Nickel &amp; Copper Plating</b> Face & Door (see "Conditions and Exclusions" # 9)	✓		
<b>Accessories</b> Firebacks, Power Heat Ducts, Andirons, etc...	✓		
<b>One-Way Freight Allowance</b> One-way freight allowance on pre-authorized repair done at factory is covered.	✓	✓	
<b>Convection Heat Exchanger</b> Convection heat exchanger assembly	✓	✓	
<b>Firebox Assembly</b> Adjustable Air Restrictor, Pressure Relief Mechanisms, Glass Attachment Mechanism	✓	✓	✓

#### EXCLUDED COMPONENTS:

Paint, Gasketing, and Accent Light Bulbs

#### **CONDITIONS & EXCLUSIONS**

- This new gas appliance must be installed by a qualified gas appliance technician. It must be installed, operated, and maintained at all times in accordance with the instructions in the Owner's Manual. Any alteration, willful abuse, accident, neglect, or misuse of the product shall nullify this warranty.
- This warranty is non-transferable and is made to the ORIGINAL purchaser, provided that the purchase was made through an authorized TRAVIS dealer.
- Discoloration and some minor expansion, contraction, or movement of certain parts and resulting noise, is normal and not a defect and, therefore, not covered under warranty. The installer must ensure the appliance is burning as per the rating tag at the time of installation. Over-firing (operation above the listed BTU rate) of this appliance can cause serious damage and will nullify this warranty.
- The warranty, as outlined within this document, does not apply to the chimney components or other Non-Travis accessories used in conjunction with the installation of this product. If in doubt as to the extent of this warranty, contact your authorized TRAVIS retailer before installation.
- Travis Industries will not be responsible for inadequate performance caused by environmental conditions such as nearby trees, buildings, rooftops, wind, hills, or mountains or negative pressure or other influences from mechanical systems such as furnaces, fans, clothes dryers, etc.
- This Warranty is void if:
  - The unit has been operated in atmospheres contaminated by chlorine, fluorine, or other damaging chemicals.
  - The unit is subject to submersion in water or prolonged periods of dampness or condensation.
  - Any damage to the unit, combustion chamber, heat exchanger, or other components due to water, or weather damage which is the result of, but not limited to, improper chimney/venting installation.
- Exclusions to this 7 Year Warranty include: injury, loss of use, damage, failure to function due to accident, negligence, misuse, improper installation, alteration or adjustment of the manufacturer's settings of components, lack of proper and regular maintenance, damage incurred while the appliance is in transit, alteration, or act of God.
- This 7 Year warranty excludes damage caused by normal wear and tear, such as paint discoloration or chipping, worn or torn gaskets, corroded or cracked logs, embers, etc. Also excluded is damage to the unit caused by abuse, improper installation, modification of the unit, drilling of the orifices, or the use of fuel other than that for which the unit is configured. Units are shipped for natural gas and must be converted to propane using the included conversion kit. Confirm fuel configuration with your installer.
- Damage to gold or nickel surfaces caused by fingerprints, scratches, melted items, or other external sources left on the gold or nickel from the use of cleaners other than denatured alcohol is not covered in this warranty.
- TRAVIS INDUSTRIES, INC. is free of liability for any damages caused by the appliance, as well as inconvenience expenses and materials. Incidental or consequential damages are not covered by this warranty. In some states, the exclusion of incidental or consequential damage may not apply.
- This warranty does not cover any loss or damage incurred by the use or removal of any component or apparatus to or from the gas appliance without the express written permission of TRAVIS INDUSTRIES, INC. and bearing a TRAVIS INDUSTRIES, INC. label of approval.
- Any statement or representation of TRAVIS products and their performance contained in TRAVIS advertising, packaging literature, or printed material is not part of this 7-year warranty.
- This warranty is automatically voided if the appliance's serial number has been removed or altered in any way. If the appliance is used for commercial purposes, it is excluded from this warranty.
- No dealer, distributor, or similar person has the authority to represent or warrant TRAVIS products beyond the terms contained within this warranty. TRAVIS INDUSTRIES, INC. assumes no liability for such warranties or representations.
- Travis Industries will not cover the cost of the removal or re-installation of hearths, facing, mantels, venting, or other components.
- If for any reason any section of this warranty is declared invalid, the balance of the warranty remains in effect and all other clauses shall remain in effect.
- THIS 7 YEAR WARRANTY IS THE ONLY WARRANTY SUPPLIED BY TRAVIS INDUSTRIES, INC., THE MANUFACTURER OF THE APPLIANCE. ALL OTHER WARRANTIES, WHETHER EXPRESS OR IMPLIED, ARE HEREBY EXPRESSLY DISCLAIMED AND PURCHASER'S RECOURSE IS EXPRESSLY LIMITED TO THE WARRANTIES SET FORTH HEREIN.**

#### **IF WARRANTY SERVICE IS NEEDED:**

- If you discover a problem that you believe is covered by this warranty, you MUST REPORT it to your TRAVIS dealer WITHIN 30 DAYS, giving them proof of purchase, the purchase date, and the model name and serial number.
- Travis Industries has the option of either repairing or replacing the defective component.
- If your dealer is unable to repair your appliance's defect, he may process a warranty claim through TRAVIS INDUSTRIES, INC., including the name of the dealership where you purchased the appliance, a copy of your receipt showing the date of the appliance's purchase, and the serial number on your appliance. At that time, you may be asked to ship your appliance, freight charges prepaid, to TRAVIS INDUSTRIES, INC. TRAVIS INDUSTRIES, INC., at its option, will repair or replace, free of charge, your TRAVIS appliance if it is found to be defective in material or workmanship within the time frame stated within this 7-year warranty. TRAVIS INDUSTRIES, INC. will return your appliance, freight charges (years 1 to 5) prepaid by TRAVIS INDUSTRIES, INC., to your regional distributor, or dealership.
- Check with your dealer in advance for any costs to you when arranging a warranty call. Mileage or service charges are not covered by this warranty. This charge can vary from store to store.



**LP Conversion Instructions****WARNING**

This conversion kit shall be installed by a qualified service agency in accordance with the manufacturer's instructions and all applicable codes and requirements of the authority having jurisdiction. If the information in these instructions is not followed exactly, a fire, explosion, or production of carbon monoxide may result causing property damage, personal injury, or loss of life. The qualified service agency is responsible for the proper installation of this kit. The installation is not proper and complete until the operation of the converted appliance is checked as specified in the manufacturer's instructions supplied with the kit.

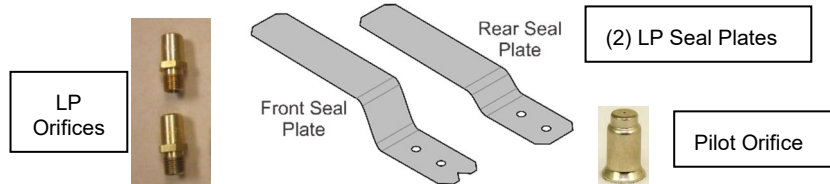
**Packing List****Convert the appliance prior to installing the gas line to ensure proper gas use.**

The GSR Stepper Motor Kit (4-pack = 94400999), (single = 250-01463) is required for converting this appliance to LP. The kit contains the stepper motor (regulator) and Torx wrench.

1. Access the firebox.
2. Remove the (8) screws that secure the media tray to the burners (set the screws aside for re-installation). Lift the media tray and remove it from the firebox.



3. Remove the (2) screws that secure the burners to the floor of the firebox (set screws aside for re-installation).

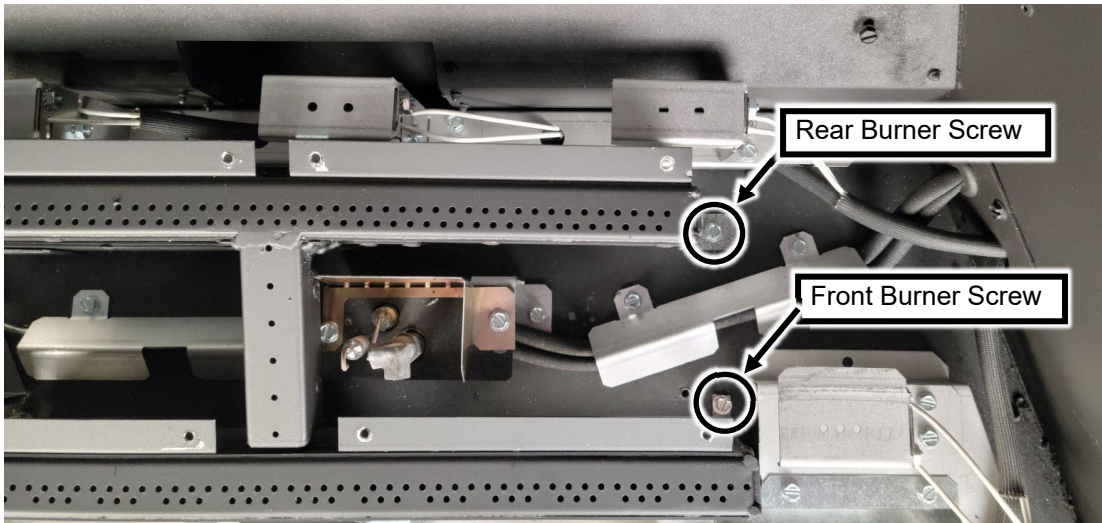

4. Lift the front burner and remove it from the firebox.

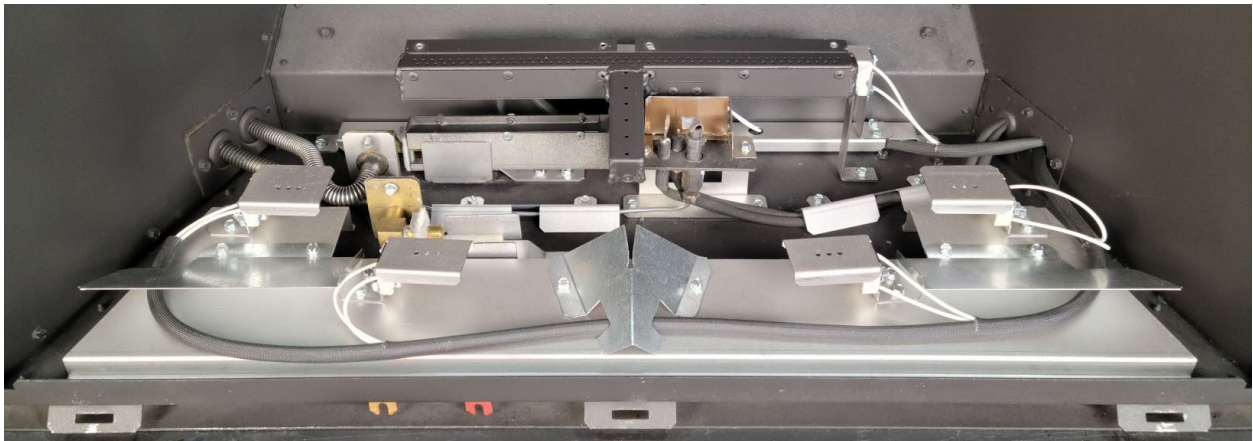

5. Lift the rear burner and remove it from the firebox.



6. Remove and discard the stock seal plates. Install the LP seal plates as shown below.

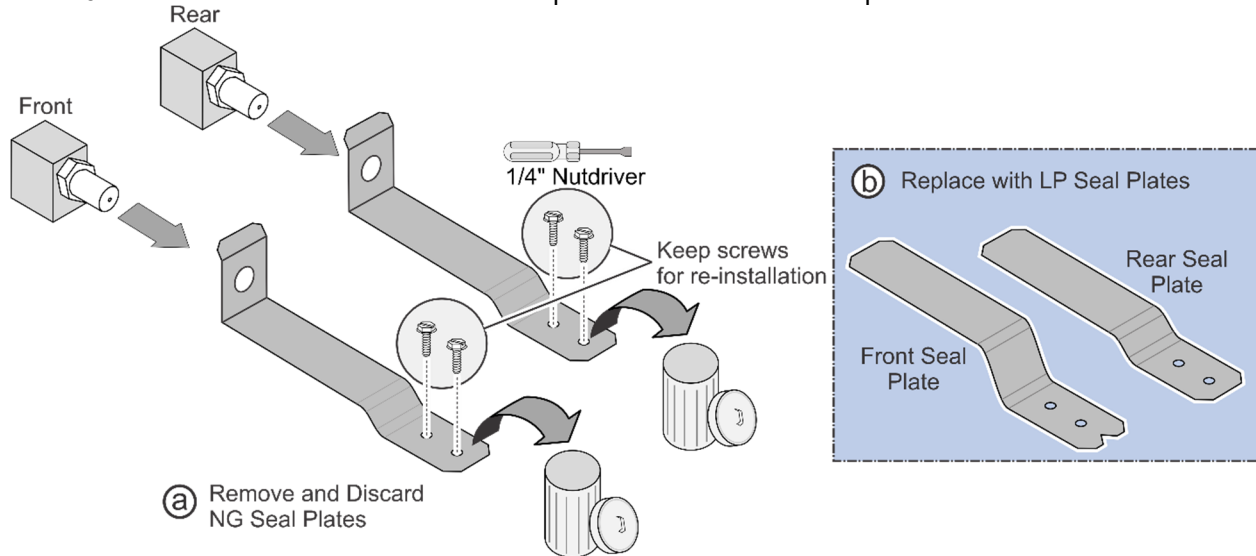

7. Install the LP (propane) orifices.

Apply thread sealant to the LP orifices prior to installation. Use the chart below to identify the correct orifices.

Screw each LP orifice until orifice protrudes 15/16" (23.8mm) indicating full insertion (use wrench to support manifold when re-attaching orifice).

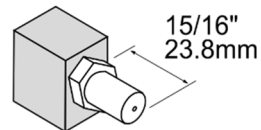

ORIFICE SIZE (ID)	Natural Gas	LP (Propane)
Front Burner Orifice	#46 DMS	#56 DMS
Rear Burner Orifice	#43 DMS	#55 DMS

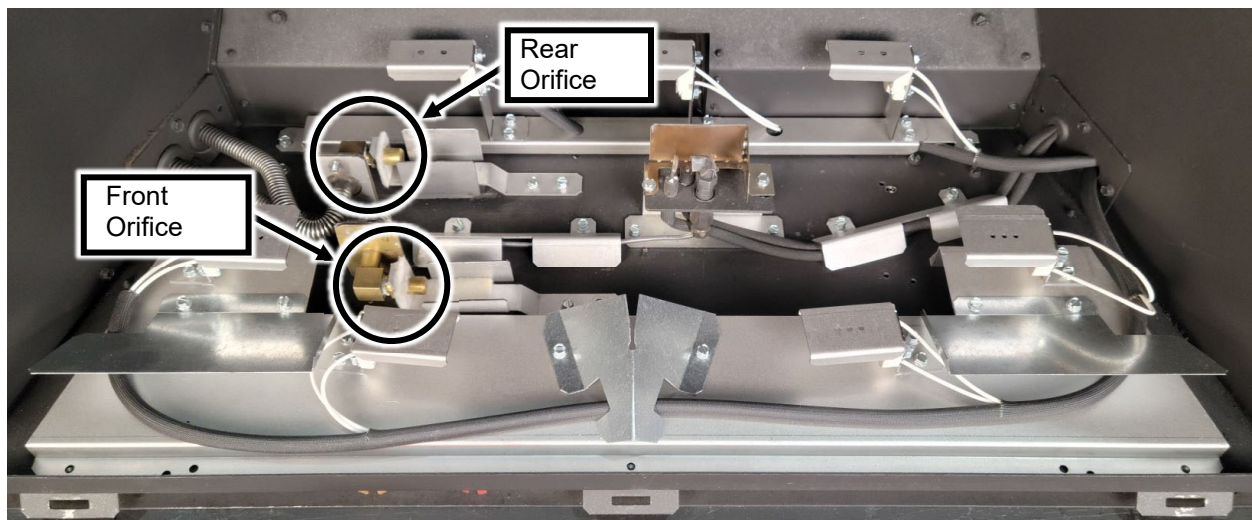

8. Install the LP pilot orifice following the directions below.
  - (a) Use a 7/16" open-end wrench to remove the pilot hood.
  - (b) Remove and discard the Natural Gas (NG) orifice. Place the LP orifice in the pilot assembly then replace the pilot hood, tightening the pilot hood until it is snug (do not over-tighten).

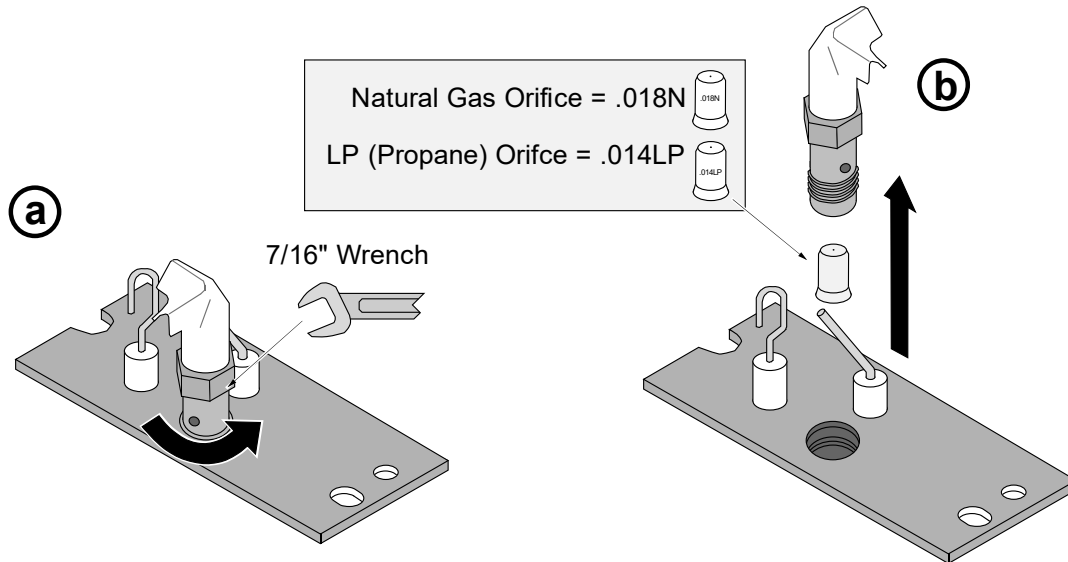

9. Replace the firebox components. Restore the fireplace to the correct configuration. Install the firebacks before re-installing the burner.
10. Access the stepper motor (shown below). The stepper motor (adjustable regulator) has an installation sheet included with it – make sure to follow all of the directions. Disconnect the wiring from the stepper motor. Remove the stock stepper motor and replace it with the LP version. – **MAKE SURE IT IS CORRECTLY ORIENTED.** Secure using the screws included with the motor – tighten to 25 Lb.-inches. Leak test this area after installation to verify proper installation. Re-attach the wiring.



11. Restore the appliance to the correct configuration. Make the gas line connection, bleed the gas line (if applicable), start the heater, and thoroughly leak-test all gas connections and the gas control valve.

## Fireback Installation

### Packing List

- (1) Rear Fireback
- (1) Left Fireback
- (1) Right Fireback

#### **GLASS FIREBACK WARNINGS**

**HANDLING THE FIREBACKS:** The glass firebacks are fragile – especially the edges. Take care to prevent contacting/scraping the glass against metal or rough surfaces. You may wish to lay out a blanket during installation in case you need to set the firebacks down.

We recommend the use of gloves and safety glasses during the installation of the glass firebacks.

#### **CLEANING**

These firebacks require periodic cleaning. Do not use ammonia-based cleaners (this may cloud the glass). We recommend ammonia-free glass cleaner (i.e. vinegar and water) to clean the fireback.

#### **CURING BLACK-PAINTED FIREBACKS**

The black painted firebacks will fully cure under heat. Run the appliance on low for several hours to cure the paint. The firebacks may be touched up using Forrest “Metallic Black” paint.

### Installation



The firebacks are installed with the media tray removed.

**See the owner’s manual for full details on the order of installation.**

1. Remove the media tray (see Owner’s Manual).
2. Remove the two side fireback clips from the firebox ceiling. They are located at the outward edges of the firebox near the glass opening.



The side fireback clip has a keyhole slot. It can be removed by loosening the screw and sliding the clip out.

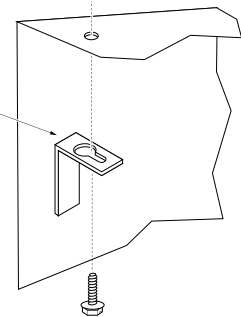

3. Place the rear fireback inside the firebox as shown below.

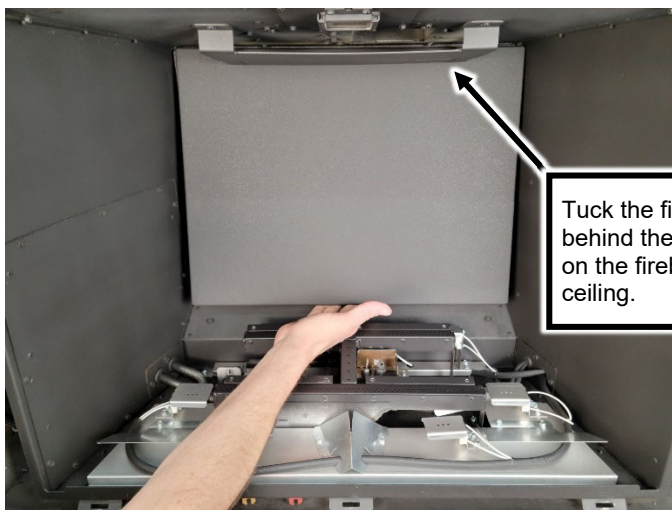

Tuck the fireback behind the baffle on the firebox ceiling.



4. With the rear fireback resting in place, install the left fireback into the firebox as shown below.



5. Replace the left fireback clip to secure the right fireback in place.



6. Install the right fireback and secure using the fireback clip. The firebox should now look like the photo below.

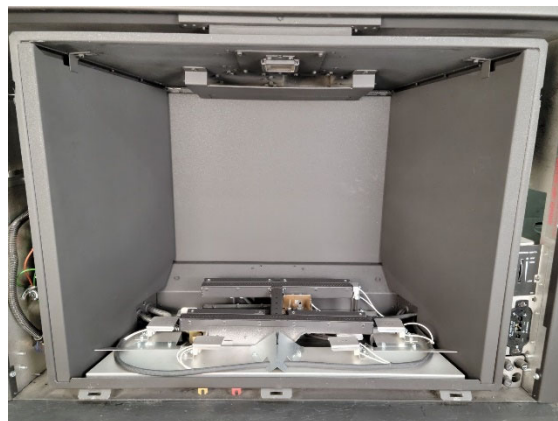

7. Replace the media tray. Screw the media tray down to the burner.  
**NOTE:** The tray may not fit unless the firebacks are all the way against the fireback walls.



8. After the media tray is installed, use a 1/4" nut driver to loosen the screws (3 per side) on the side media tray filler brackets. Slide the brackets toward the side firebacks until they are touching the panels and retighten the screws to secure the brackets in place.

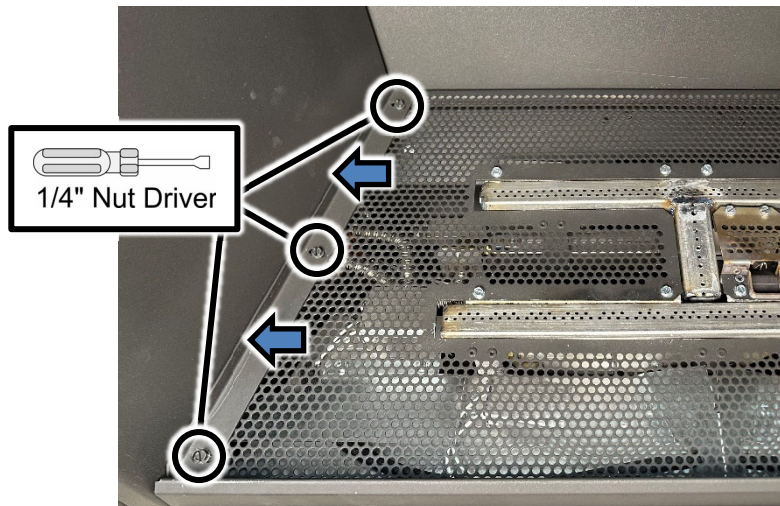

9. When the fireback installation is complete, it should look like the picture below.

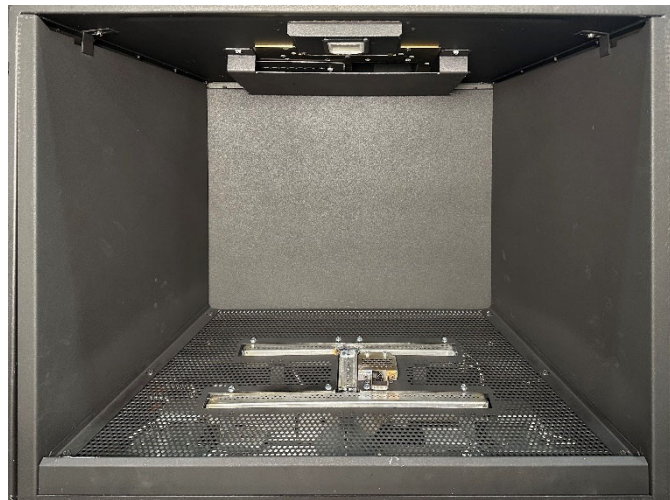

Media Options - Overview

**! WARNINGS !**



- **Only use media provided by Travis Industries.** The use of any other materials inside this appliance could create hazardous conditions and may result in property damage, bodily injury, or even death
- **Make sure the gas control valve is OFF and the heater is cool prior to conducting service.**
- **If using propane (LP), convert the appliance before installing the media**
- **This appliance requires the use of a fireback kit. Install the Fireback BEFORE installing the media.**

**Overview**

The 616 Mod-Fyre requires “media” to complete the installation. This insert is very flexible with the placement of the media, which allows the look to be customized to fit your aesthetic tastes. At a minimum, every installation requires a base layer of spreadable media (Crushed Glass or Embers and Ember-Glo (EG) Glass kit) to cover the media tray and burners. The following base layer materials are available:

- Crushed Glass - Platinum - sku# 94500580
- Crushed Glass - Bronze - sku# 94500581
- Crushed Glass - Cobalt - sku# 94500582
- Crushed Glass - Black - sku# 94500583
- Embers and EG Glass kit - sku# 94500943

Additionally, you can choose to add a Log and Stone kit to add additional visual points of interest in the firebox. The following log and stone kits are available:

<p><b><u>Driftwood and Stones</u></b> sku# 94500960</p>	<p><b><u>Birch and Stone</u></b> sku# 94500942</p>
	
<p><b><u>Tumbled Stones</u></b> sku# 94500961</p>	
	



**Crushed Glass Installation (Optional)****! WARNINGS !**

- **Do not allow the crushed glass to block the air slots or to become too thick (maximum 1 layer deep on the burner). Failure to properly install glass may lead to sooting and poor performance.**
- **Make sure the gas control valve is OFF and the heater is cool prior to conducting service.**
- **If using propane (LP), convert the appliance before installing the media**
- **This appliance requires the use of a fireback kit. Install the Fireback BEFORE installing the media.**

**Measuring Glass Quantity**

Travis Industries offers glass in 10-lb. boxes. The 616 Mod-Fyre uses **8 lbs.** of glass so it is important to measure out the appropriate amount of glass for installation. Use a liquid measuring cup to accurately determine the amount of glass used.

**1 Level Cup (8 fl. oz.) (240ml) = 0.95 lbs.**

**So...1 Slightly Rounded Cup = 1 lb.**



1. Use a 1/4" nut driver to remove (2) screws that secure the pilot cover to the media tray and remove the pilot cover. Gently pull the silicone sleeve from the spark electrode on the pilot assembly and re-install the pilot cover (make sure not to overtighten the screws).

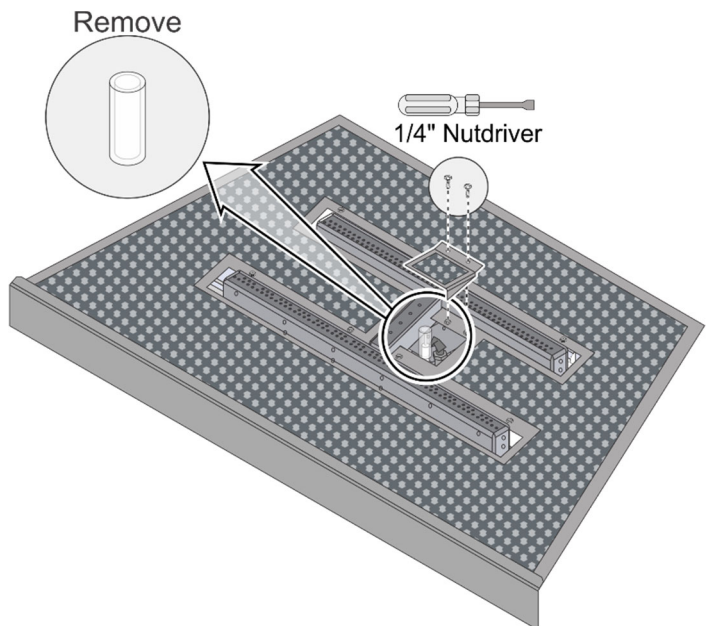

# 58

## Optional Equipment (for qualified installers only)

2. Spread an even layer of crushed glass over the media tray and burner. The glass must be only (1) layer thick on the burners but can be (2) layers thick on the media tray.



3. Make sure glass does not drop down into the pilot area below the cover and that the opening indicated below remains open.

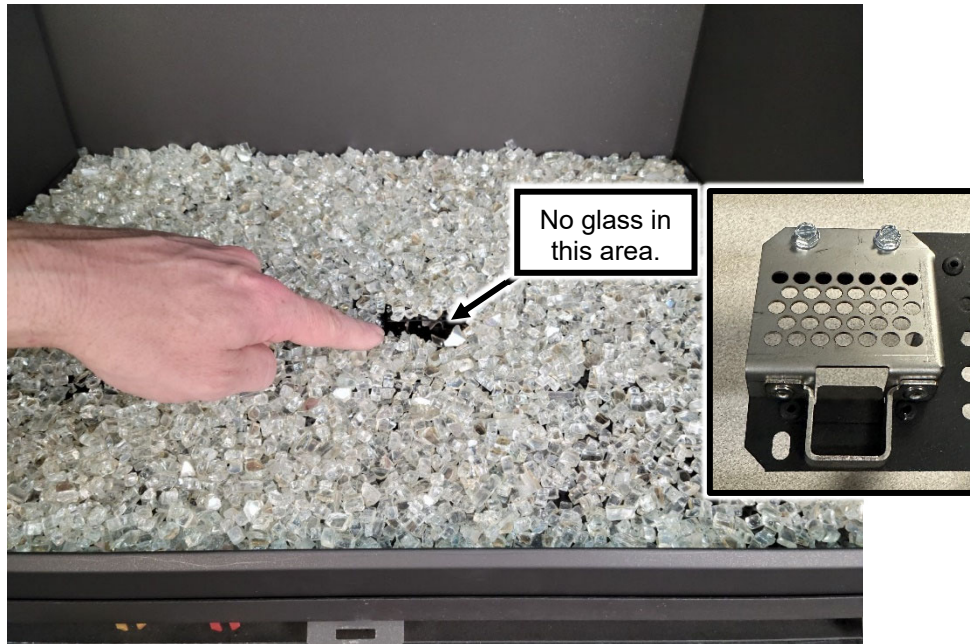

4. The firebox should look like the picture below when the glass installation is complete.



**Embers and EG Glass (Optional)****! WARNINGS !**

- **Do not allow the glass or rock material to block the air slots or to become too thick (maximum 1 layer deep on the burner). Failure to properly install the Rock Ember material may lead to sooting and poor performance.**
- **Make sure the gas control valve is OFF and the heater is cool prior to conducting service.**
- **If using propane (LP), convert the appliance before installing the media**
- **This appliance requires the use of a fireback kit. Install the Fireback BEFORE installing the media.**

**Overview**

This kit comes with ember glass (4lbs) and (2) sizes of ember material (1/2 lb. of small rocks and 4lbs of large rocks).

**Amount of Ember Rock Needed:**

- Ember-Glo Glass - 4 lbs. (approximately 4 cups).
- Small Rock - 1/2 lbs. (approximately 1-1/4 cups).
- Large Rock - 4 lbs. (approximately 11 cups).

**Installation Notes**

- Discard rock at the bottom of the bag that has disintegrated (turned to small, sand-like material).
- Put down the EG glass first. Cover the entire media tray with EG Glass (Do not cover the burner).
- Put down the large rock next. Cover the EG glass with large rock.
- **NOTE: Do not place large rocks over any burner ports** (This will cause sooting).
- Place one layer of small Ember Rock over the burners.
- Do not stack media in piles that may fall over or block airflow.



***Driftwood and Stones (Optional)*****! WARNINGS !**

- **Do not place logs over the burner ports**
- **Install a base layer of either Crushed Glass or Embers & EG Glass before placing any of this media kit.**
- **Make sure the gas control valve is OFF and the heater is cool prior to conducting service.**
- **If using propane (LP), convert the appliance before installing the media**
- **This appliance requires the use of a fireback kit. Install the Fireback BEFORE installing the media.**

**Overview**

This kit contains 13 pieces of non-combustible media used to decorate the firebox. You may use as few or as many of the logs and stones as you would like to achieve the desired look. Any extra stones or driftwood may be kept for future use.

**Packing List**

- 5 Pieces of Driftwood
- 8 Stones

**Placing the Media**

Randomly place the media on top of the Crushed Glass or Ember media.

- **DO NOT PLACE MEDIA OVER BURNER PORTS (THIS WILL CAUSE SOOTING).**
- **DO NOT STACK MEDIA IN PILES THAT MAY FALL OVER OR BLOCK AIRFLOW**



***Birch and Stone (Optional)*****! WARNINGS !**

- **Do not place logs over the burner ports**
- **Install a base layer of either Crushed Glass or Embers & EG Glass before placing any of this media kit.**
- **Make sure the gas control valve is OFF and the heater is cool prior to conducting service.**
- **If using propane (LP), convert the appliance before installing the media**
- **This appliance requires the use of a fireback kit. Install the Fireback BEFORE installing the media.**

**Overview**

This kit contains 12 pieces of non-combustible media used to decorate the firebox. You may use as few or as many of the logs and stones as you would like to achieve the desired look. Any extra stones or logs may be kept for future use.

**Packing List**

- 5 logs
- 7 Stones

**Placing the Media**

Randomly place the media on top of the Crushed Glass or Ember media.

- **DO NOT PLACE MEDIA OVER BURNER PORTS (THIS WILL CAUSE SOOTING).**
- **DO NOT STACK MEDIA IN PILES THAT MAY FALL OVER OR BLOCK AIRFLOW**



***Tumbled Stone (Optional)*****! WARNINGS !**

- **Do not place stones over the burner ports**
- **Install a base layer of either Crushed Glass or Embers & EG Glass before placing any of this media kit.**
- **Make sure the gas control valve is OFF and the heater is cool prior to conducting service.**
- **If using propane (LP), convert the appliance before installing the media**
- **This appliance requires the use of a fireback kit. Install the Fireback BEFORE installing the media.**

**Overview**

This kit contains 30 pounds of tumbled stone used to decorate the firebox. You may use this kit alone or in addition to the other log kits available for this insert. Because this kit includes more than enough stones, we recommend extra stones be kept for future use.

**Packing List**

- Small Stones - 10 lbs.
- Large Stones - 20 lbs.

**Placing the Media**

Randomly place the media on top of the Crushed Glass or Ember media.

- **DO NOT PLACE MEDIA OVER BURNER PORTS (THIS WILL CAUSE SOOTING).**
- **DO NOT STACK MEDIA IN PILES THAT MAY FALL OVER OR BLOCK AIRFLOW**



***Media Examples and Recipes*****Driftwood Twigs, Stones, and Glass Example****Recipe**

- Driftwood and Stone Log set: 94500960
- Crushed Glass - Platinum: 94500580
  - Qty. used: 8 lbs.

**Driftwood, Stones, and Embers & EG Glass Example****Recipe**

- Driftwood and Stone Log set: 94500960
- Embers & EG Glass: 94500943
  - EG glass qty. used: 4 lbs.
  - Small rock qty. used: 1/2lb
  - Large rock qty. used: 4 lbs.

**Birch Logs, Stones and Glass Example****Recipe**

- Birch and Stone Set: 94500942
- Crushed Glass - Platinum: 94500580
  - Qty. used: 8 lbs.

**Birch Logs, Stones, and Embers & EG Glass Example****Recipe**

- Birch and Stone Set: 94500942
- Embers and EG Glass kit: 94500943
  - EG glass qty. used: 4 lbs.
  - Small rock qty. used: 1/2 lb
  - Large rock qty. used: 4 lbs.









Accent Light Replacement .....	39	Leveling Legs .....	12
Additional Items Required .....	7	Listing Details .....	2
Air Shutter Adjustment .....	26	Location of Controls .....	30
Altitude Considerations .....	18	Low Battery Indicator .....	37
Battery Replacement .....	37	LP Conversion Instructions .....	48
Before You Begin .....	28	Maintaining Your Heater's Appearance .....	39
Birch and Stone (Optional) .....	60	Mantel Clearances .....	10
Childproof Feature .....	38	Masonry Fireplace Hearth Requirements .....	8
Clearances .....	10	Media Examples and Recipes .....	62
Crushed Glass Installation (Optional) .....	56	Normal Operating Odors .....	38
Dimensions .....	6	Normal Operating Sounds .....	38
Direct Operation .....	30	Order of Installation .....	7
Display Fahrenheit or Celsius .....	36	Packing List .....	7
Driftwood and Stones (Optional) .....	59	Pilot Fuel Conservation Timer .....	32
Electrical Requirements .....	13	Power Outages .....	37
Electrical Specifications (for blowers) .....	6	Remote Control Warnings .....	28
Embers and EG Glass (Optional) .....	58	Remote Operation .....	33
Exhaust Restrictor Settings .....	21	Remote Set-Up .....	29
Factory-Built (Metal) Wood-Burning Fireplace Requirements .....	9	Removing Media Tray for Fireback Installation ...	27
Features .....	6	Replacement Parts .....	45
Fireplace Clearances to Gas Insert .....	8	Safety Label .....	46
Fireplace Requirements .....	8	Starting the Heater for the First Time .....	30
Fuel .....	6	Steps for Finalizing the Installation .....	25
Gas Inlet Pressure .....	14	Televisions Placed Above the Insert .....	11
Gas Line Installation .....	15	Troubleshooting Table .....	43
Gas Line Requirements .....	14	Tumbled Stone (Optional) .....	61
Glass Frame Removal and Installation .....	24	Under Light Bulb Replacement .....	40
Hearth Requirements .....	9	Upper Accent Lights .....	39
Heating Specifications .....	6	Vent Attachment – Tight Installations .....	19
Important Information .....	2	Vent Configurations .....	18
Installation Options .....	6	Vent Installation .....	17
Installation Warnings .....	7	Vent Location .....	18
Intermittent/Continuous Pilot .....	31	Vent Requirements .....	16
Introduction .....	2	Wiring Diagram .....	44
		Yearly Service Procedure .....	42

## Want to know more?

Scan this code with a QR reader on your cell phone or use the URL below to watch a video of how to use the GreenSmart® remote.



<https://vimeo.com/84052701>